

A TRNSYS Simulation Case Study on Utilization of Heat Pump For both Heating and Cooling

S.M. Al-Zahrani^[a]; F.L. Tan^{[b],*}; F.H. Choo^[c]

^[a]King Saud University, Chemical Engineering Department, P.O. Box 800, Riyadh 11421, Saudi Arabia.

^[b]Nanyang Technological University, School of Mechanical and Aerospace Engineering, 50 Nanyang Avenue, Singapore.

^[c]Nanyang Technological University, School of Electrical and Electronics Engineering, 50 Nanyang Avenue, Singapore.

*Corresponding author.

Funded by King Saud University (KSU) and Nanyang Technological University (ERI@N)

Received 20 April 2012; accepted 14 May 2012

Abstract

This paper presents a TRNSYS simulation case study on the integration of a heat pump into a hot water and cold water storage systems for the purpose of providing heating and cooling to a residential home or office building in a tropical climate. The motivation is to utilize waste heat rejected by the heat pump. The heat pump is integrated with two water storage tanks. One is the cold water tank where heat is extracted by the heat pump and the other is the hot water which stores the heat rejected by the heat pump. The cold water tank provides cooling water for air conditioning to the building. The hot water tank is used for daily usage like bathing and washing. The sizing of the two storage tanks and the balancing of the heat transfer between the two tanks are important design factors to maintain suitable temperatures in the storage tanks. The paper discusses the performance of the integrated system under different operational modes and the effects of each storage tank size on the performance.

Key words: Heat pump; Heating; Cooling; TRNSYS; Simulation; Air conditioning

Al-Zahrani, S.M., Tan, F.L., & Choo, F.H. (2012). A TRNSYS Simulation Case Study on Utilization of Heat Pump for both Heating and Cooling. *Energy Science and Technology*, 3(2), 84-92. Available from: URL: <http://www.cscanada.net/index.php/est/article/view/10.3968/j.est.1923847920120302.397>
 DOI: <http://dx.doi.org/10.3968/j.est.1923847920120302.397>

Nomenclature

Q_c	Heat absorbed from the cold tank (kJ/hr)
Q_h	Heat rejected to hot tank (kJ/hr)
γ_c	Output signal from cold tank differential controller
γ_h	Output signal from hot tank differential controller
T_a	Ambient temperature (°C)
V_a	Flow rate of ambient air cooled by cooling coil and supplied to space (L/hr)
V_{hw}	Flow rate of hot water used for daily usage (L/hr)

INTRODUCTION

Increase of oil price and its depletion along with globalwarming have pushed various researches to study and utilize alternative energy available to meet mankind needs. This resulted in the current vast development of various clean energy industries in various countries. In addition of finding new alternative energy to meet energy consumption and demand, researches are also looking into ways to maximize the usage of low quality heat rejected by the equipment to be used for various applications such as cooling or heating. The utilization efficiency of the energy can be increased through the use of waste heat instead of rejecting it to ambient. One solution is the use of heat pump in a residential home or office building for both cooling and heating.

A heat pump transfers heat energy from lower-temperature space to higher-temperature space, through the input of electrical energy. Baek, Shin & Yoon (2005) studied and analyzed the application of heat pump system in Korea, for supplying hot water using heat from sauna waste water as the heat source. They found that average annual COP was 4.5 to 5, which is higher than heat pump with ambient air heat source and that it can provide 90% of the instant hot water load.

In addition, heat pump can also be used for both cooling and heating application, depending on the needs.

Zhang, Ge & Ye (2007) modeled an application of heat pump for space heating and cooling with water pond as seasonal energy storage. They modeled the effects of several parameters like the type of soil, water pond volume for three different operational modes. They concluded that by running the heat pump in both heating and cooling mode throughout a year will incur energy savings in compressor work. Chen, Sun, Feng, & Liu (2005) reported water-source heat-pump air conditioning system for a tall apartment in Beijing. They studied that using a water-source water-loop heat pump system in the air-conditioning system would be more economical and saved more energy compared to central-air conditioning system.

Experimental test involving heat pump utilizing ground-heat-source water for cooling and heating application were studied by Lim, Lee, & Lee (2009). The test building had an area of 329 m², with a cooling and heating load of 52,607 and 66,291 kcal/hr respectively. In the experiment, the storage tank was charged to over 40 per cent of the cooling and heating load during the day, corresponding to a required capacity of 46 metric tons.

Many studies or experimental setup use ground water

or a reservoir to provide the cooling and heating to the heat pump. This paper presents a case study to explore the feasibility of using a water-to-water heat pump to provide cold water for cooling and hot water for heating through TRNSYS simulation. The heat pump is coupled to two storage tanks. One is the cold water tank where heat is extracted by the heat pump and the other is the hot water tank which stores the heat rejected by the heat pump. The cold water tank provides cooling water for air conditioning to the building. The hot water tank is used for meeting the hot water demands such as bathing, washing and other usage. The results from the simulation study would be discussed in this paper.

1. TRNSYS SIMULATION

The TRNSYS model simulates the application of heat pump for air conditioning and producing hot water to meet daily residential usage in Singapore and is schematically shown in Figure 1. Since the emphasis here is to provide the cooling to the space, through a chilled water tank, it will be considered running in cooling mode. The TRNSYS simulation model of the system is shown in Figure 2.

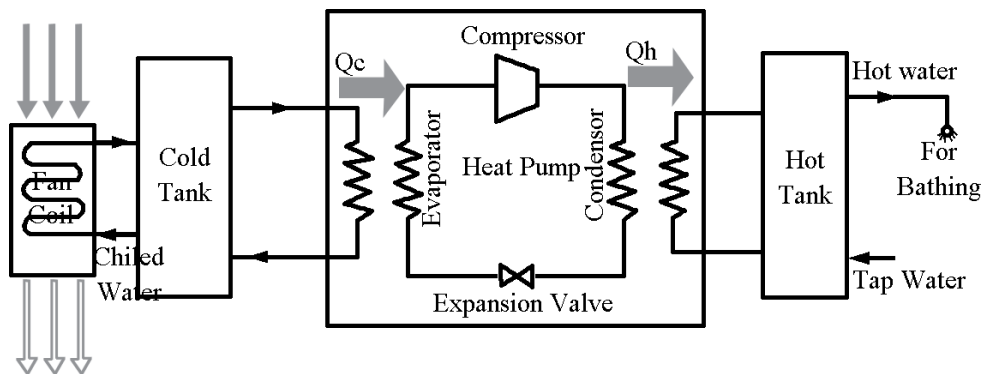

Figure 1
Schematic Diagram of Heat Pump for Air Conditioning and Hot Water Production

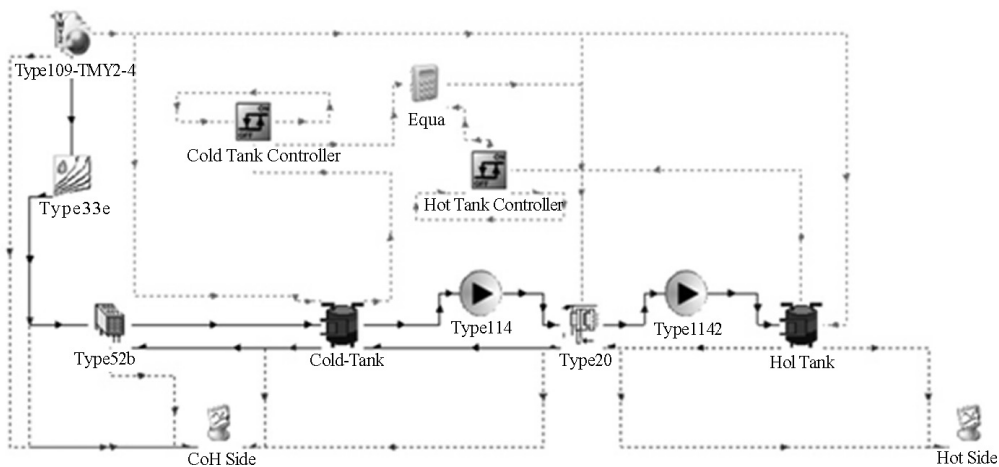

Figure 2
Schematic Diagram of Heat Pump for Air Conditioning and Hot Water Production

Cold water from the cold water storage tank (CWST) will be used to cool ambient air to be supplied to the rooms. The hot water storage tank (HWST) serves to store the heat from the heat pump to produce hot water for bathing. The estimated average hot water storage required

for a residential house per person is around 45.5 L (Hall, 1982). An estimated hot water usage profile for a house unit consisting of 4 persons is shown in Figure 3. The air conditioning fan coil unit, on the other hand, is required to operate from 8 pm to 6 am next morning.

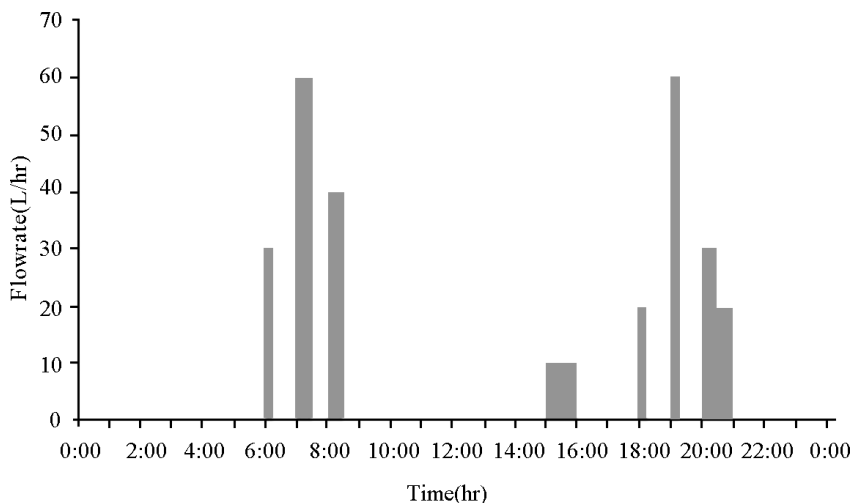

Figure 3
Average Daily Schedule for Hot Water Usage

1.1 Heat Pump Control

The cooled air supplied to the room is aimed to have temperature from 18 to 20 °C, while the hot water tank should have temperature less than 45 °C. Two differential controllers will be used to monitor the hot and cold tank

temperatures which provide output signals used as part of conditions to operate the heat pump. Together with another controller that determines the pump operation based on time set in the controller which will be discussed in the next section.

Table 1
Differential Controller Settings of the Hot and Cold Water Tanks

Hot Tank control procedure	Cold Tank control procedure
If $\gamma_h = 1$ and $T_{hot} < 45^\circ\text{C}$, $\gamma_h = 1$ Otherwise $\gamma_h = 0$.	If $\gamma_c = 1$ and $T_{cold} > 16^\circ\text{C}$, $\gamma_c = 1$ Otherwise $\gamma_c = 0$.
If $\gamma_h = 0$ and $T_{hot} \leq 40^\circ\text{C}$, $\gamma_h = 1$ Otherwise $\gamma_h = 0$	If $\gamma_c = 0$ and $T_{cold} \geq 12^\circ\text{C}$, $\gamma_c = 1$. Otherwise $\gamma_c = 0$

The settings of the differential controller of the cold tank and hot tank are shown in Table 1. The heat pump is scheduled to run from 8 am – 6 pm (day-time operation). This operation aims to determine the size of the storage tanks required, when the system operation time follows normal working hour in a building.

As the system is designed for both cooling and heating water for daily usage, the capacity of heat pump should be sufficient to produce hot thermal energy to the hot water storage tank and cold thermal energy to the cold storage tank. In addition, the volume of the storage tanks should be enough to sustain the temperature required during load discharging period. Table 2 shows the capacity of major equipment being used in the model.

1.2 Components Specification

Table 2
Information of Simulation Model

Components	Capacity	Remarks
Heat Pump	8.8 kW	Electrical energy required of 2.3 kW
Cold Water Storage Tank	0.5 m ³	Loss coefficient of 10 kJ/hr·m ² ·K
Hot Water Storage Tank	3 m ³	Loss coefficient of 10 kJ/hr·m ² ·K
Air flow rate	780 kg/hr	Between 8pm - 6am
Evaporator flow rate	1500 kg/hr	-
Water flow rate to cooling coil	800 kg/hr	-

The volume in both tanks will always be constant all the time. Hence, any water flow used will be replenished by fresh tap water to maintain constant volume for the tanks. In the model, this will particularly relates with hot water storage tank. Same amount of water at the ambient temperature will enter the tank at the lowest part of the tank to maintain stratification to replenish the hot water used as on the schedule. In the cold water tank, cold water will just be circulated between fan coil unit and the tank.

1.3 Operational Time

The model will be simulated to run under another two different operational times. The first at night time involves operation of heat pump from 7 pm – 6 am. The second day time operation involves the whole day operation of the

heat pump. In both cases, the temperature control strategy of the heat pump remains the same, as described in earlier section.

2. RESULTS AND DISCUSSION

The results of the simulation model in day-time operation are shown in Figures 4, 5 and 6. From Figure 3, it can be seen that the ambient air will be cooled to between 19 °C and 20 °C during day time where the heat pump is operating. The ambient temperature along with other weather information used in the models is typical data for Singapore which is provided by the TRNSYS weather database.

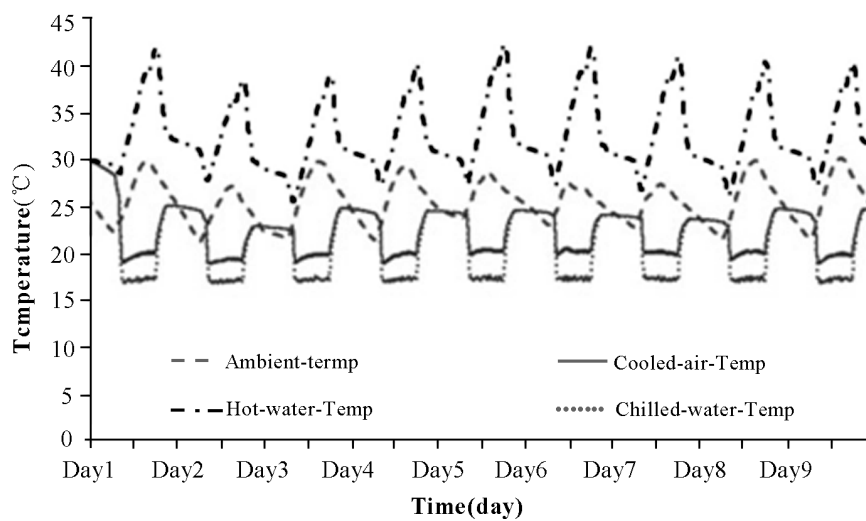

Figure 4
Cold Air Temperature Supplied to Rooms

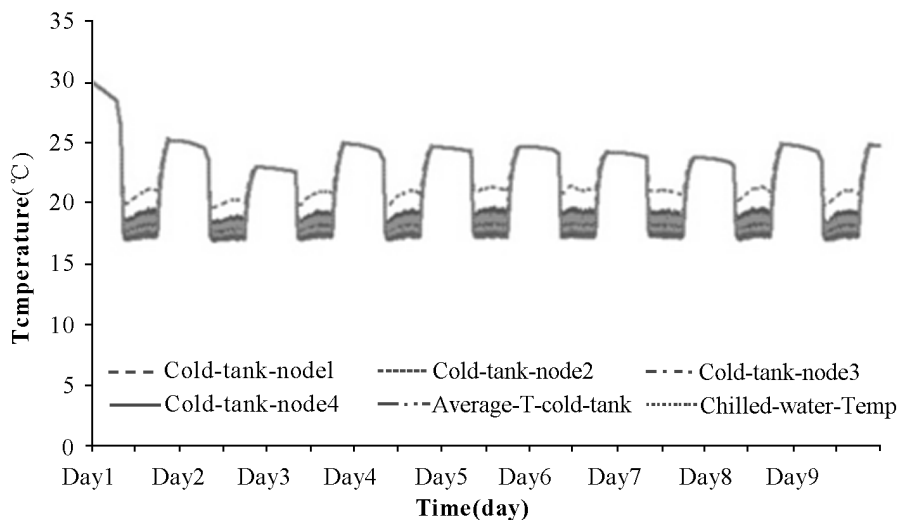

Figure 5
Average Cold Water Tank Temperature

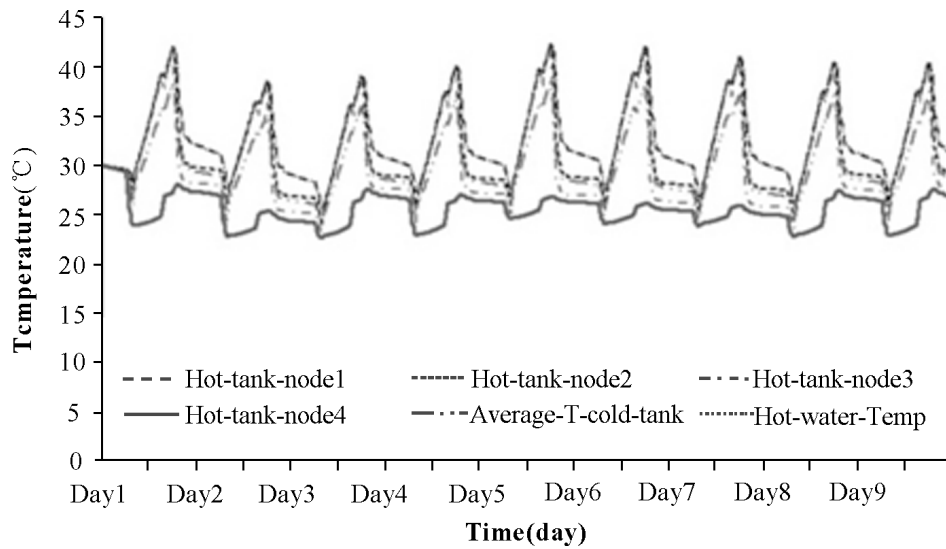

Figure 6
Average Temperature of the Hot Tank

Figures 5 and 6 show the stratification of both the cold water and the hot water tanks which are used for storing cold and hot water. Each of the tanks is modeled in a way that it consists of four stratified layers. The water temperature across each layer is assumed to be uniform. In the model operated during day time, the heights of the tanks are 1 meter.

2.1 Different Operational Modes

Osman, Al-Khaireed, Ariffin, & Senawi (2008) conducted a numerical simulation to determine the relationship between the chilled water tank size and thermal stratification. They mentioned that height-to-diameter

ratio of a chilled water tank will affect the formation of thermocline layer which affects the temperature profile with a given depth.

Comparison of some variables between different operation modes are shown in Figures 7, 8 and 9. The figures compare the cooled air temperature, average cold water tank temperature, and average hot water temperature for one day period. Here, the height-to-diameter ratio used for the chilled water tank is 1.25, which is considered low and hence produced poor thermoclines thickness, according to Osman et al. (2008).

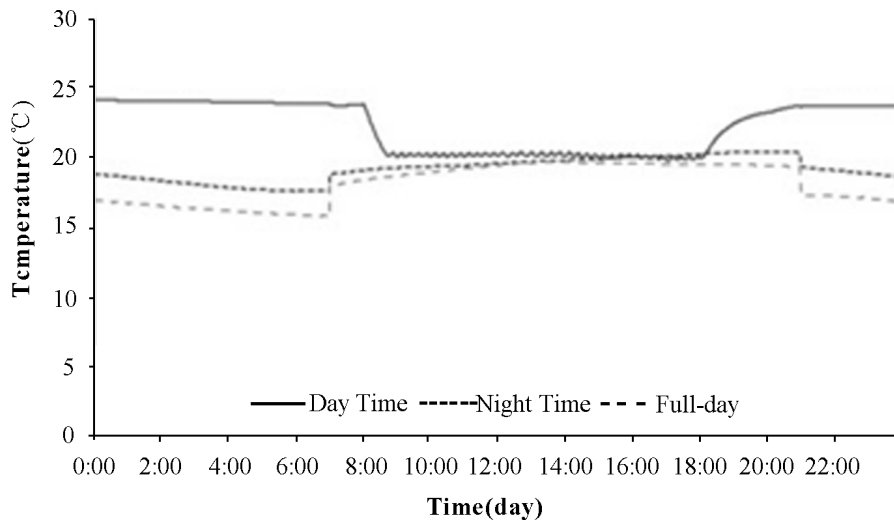

Figure 7
Comparison of Cooled Air Temperature Under Different Operating Mode

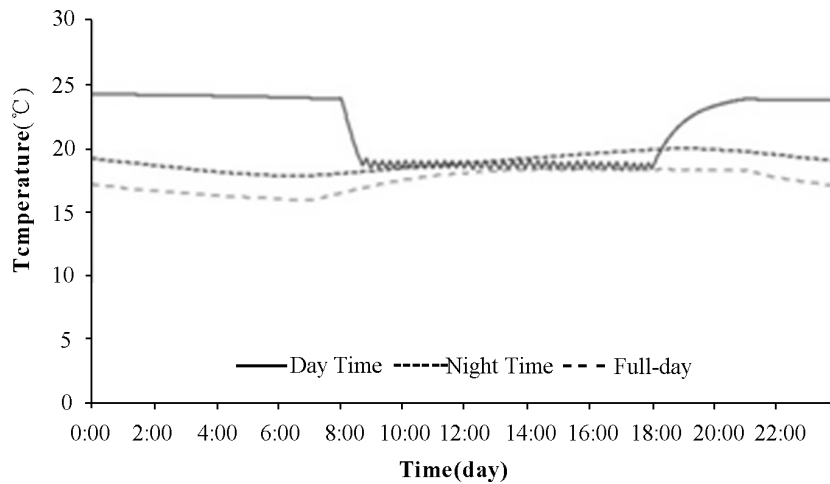

Figure 8
Comparison of Cold Water Tank Temperature Under Different Operating Mode

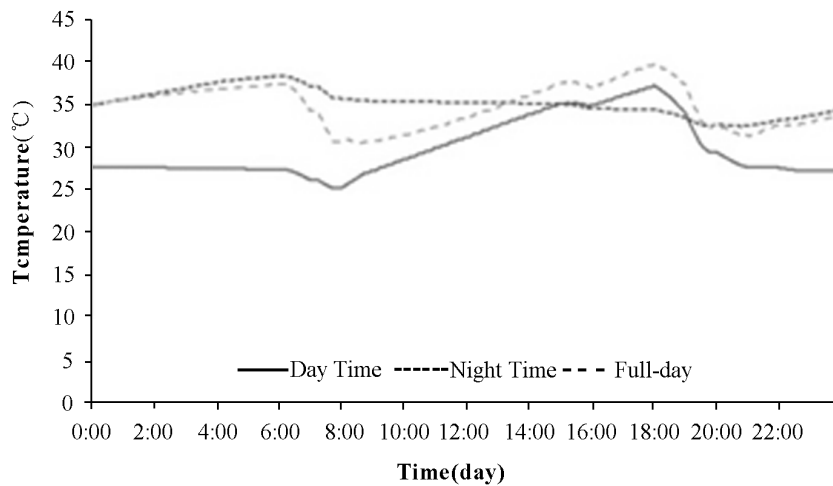

Figure 9
Comparison of Hot Water Temperature Under Different Operating Mode

For cooled air temperature, comparison should be emphasized at between 7 am to 9 pm, where the ambient air will be cooled by the fan coil unit to produce cool air to be distributed to the room. Sudden change in temperature is observed during start-up and shut-down operation of the fan coil unit. During the period where the fan-coil is not operating, the water temperature in the fan coil unit will follow the average cold water tank temperature, which is also influenced by the tank volume and heat loss from the tanks. The changes in cold water tank temperatures during start-up and shut-down is less sharp in night-time operation and whole-day operation, as compared to day-time operation due to the larger tank volume.

The hot water temperature profile in night-time operation has the least variation. This is due to the larger tank volume. In addition, since the temperature of the hot water tank is used to control the operation of the heat pump, the larger volume of hot water tank would allow more running time of the heat pump under night-time

operation. Hence, the temperature in the hot water tank builds up until 6 am and slowly goes down as the hot water consumption peaks at morning and around evening as shown in Figure 2.

In all operational modes, the size of hot storage tank is larger than the size of cold storage tank. This is because the heating and cooling load requirement is not balanced. The heat pump is used to cool the building while at the same time heating water suitable for household purposes. The heating load from hot water requirement shown in Figure 2 is lower compared to the cooling requirement. And since the heat pump operation is also controlled by the hot tank temperature, hence larger hot water storage is required to store the heat from the heat pump operation, while at the same time providing cool air for air conditioning.

Overall, all the three operational modes are able to provide cooling air, having temperature between 18 °C and 20 °C. The whole-day operational mode gives cooler

air compared to the other modes. The day-time operational mode requires the smallest size of both storage tanks.

However, the day-time operational mode is not capable of providing hot water, having temperature between 35 °C and 45 °C during early morning, while the other two operational modes can supply the hot water at the required temperatures. This day-time operational mode will be discussed in further details in later section where the

effects from the variation in parameters will be performed for the day-time operation mode.

Since the aim of the operational modes is to observe the configuration on which the system could produce sufficient cold water for air-conditioning, the water tanks volume for night-time and whole-day operation has been changed from the original volume used when simulating the day-time operation. Different volume of tanks under each simulation mode is shown in Table 3.

Table 3
Storage Tanks Size Under Different Simulation

	Day-time Operation	Night- time Operation	Whole-day Operation
Cold Water Tank (m ³)	0.5	20	5
Hot Water Tank (m ³)	3	10	3

Based on cost of the tanks, the day-time operation will require the least capital cost as the tanks sizes are the smallest. This is due to the fact that the requirement of cool air is generated during day-time. The night-time operation requires much larger storage because the cold water will only be used during day time to provide air conditioning.

2.2 Effect of Storage Tank Volume on Day-Time Operational Mode

To improve the performance of the system, under both operational modes, the effect from the cold and hot tank volume variations is observed. Figures 10 to 13 show the effect of cold and hot storage tank sizes on cold water tank temperature, hot water tank temperature, cooled air and hot water for bathing, respectively.

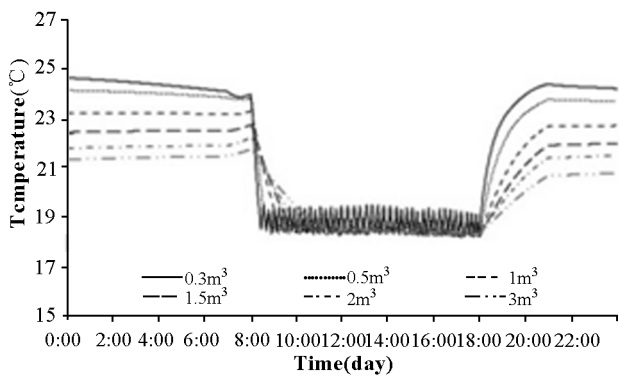

(a) Cold Tank Volume

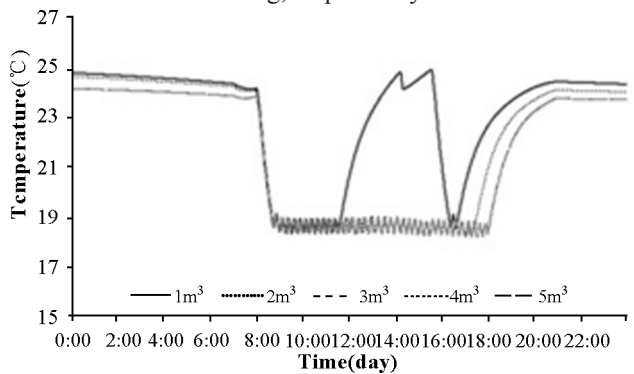

(b) Hot Tank Volume

Figure 10
Effect of Tank's Volume on Cold Water Tank Temperature

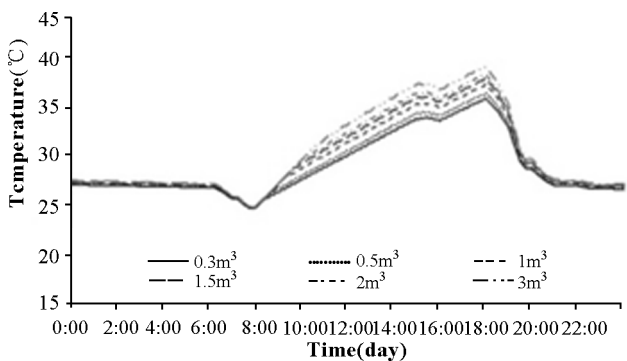

(a) Cold Tank Volume

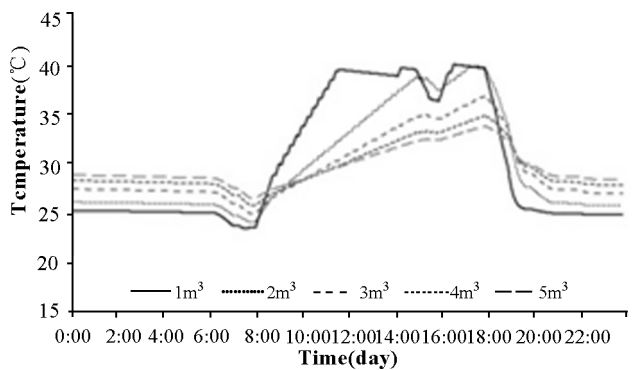

(b) Hot Tank Volume

Figure 11
Effect of Tank's Volume on Hot Water Tank Temperature

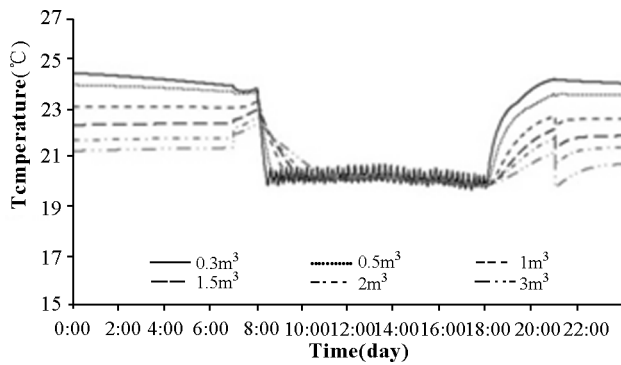

(a) Cold Tank Volume

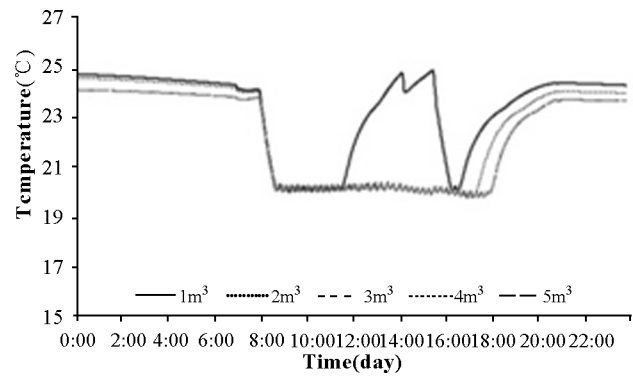

(b) Hot Tank Volume

Figure 12
Effect of Tank's Volume on Cooled Air Temperature

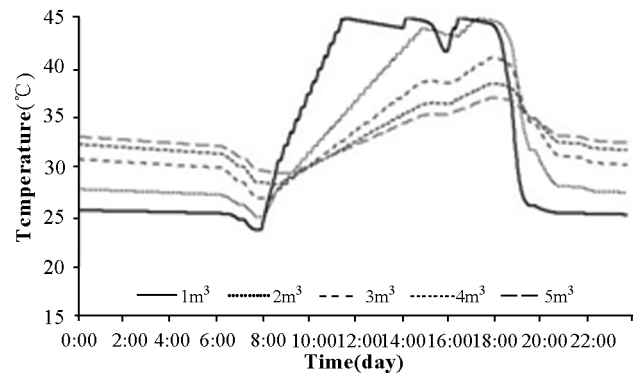
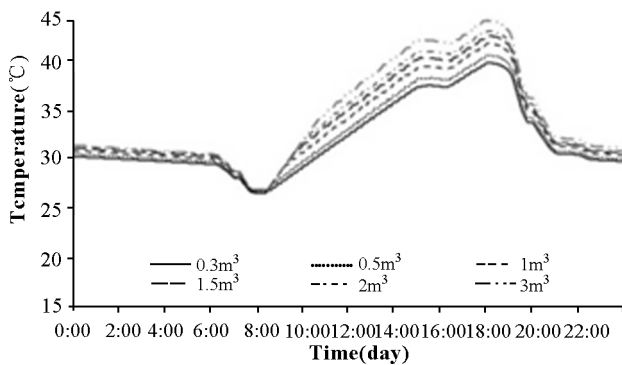

Figure 13
Effect of Tank's Volume on Hot Water Temperature

While varying volume of one tank, the volume of the other tank is maintained constant. Example when the cold water tank storage volume is being varied, the hot water tank volume is kept at 3 m³. The same goes when varying hot water tank volume, in which the cold water tank volume is kept at 0.5 m³.

The effect of cold water storage tank volume on average tank temperature is not significant during the period where heat pump is operated during day-time mode. Overall, the storage tanks volume has less effect on the cooled air temperature and the average cold tank temperature than the effect observed on the hot water storage average temperature. Depending on the required temperature, storage volume plays a greater role in meeting the cooled air temperature and hot water demand, with the precise controlling of the heat pump.

CONCLUSION

The TRNSYS simulation model integrating a heat pump, for providing cool air and hot water for a residential unit

has been presented for three different operational modes such as night-time operation of the heat pump, day-time operation and whole-day operation. The simulation shows that incorporating heat pump with two water storage tanks to provide both cooling and heating is feasible for a tropical climate such as Singapore. The cold water storage is used for air conditioning purpose and the hot water storage tank is used for bathing and washing.

ACKNOWLEDGEMENT

The research work in this paper is carried out under the joint research collaboration between King Saud University (KSU) and the Energy Research Institute at Nanyang Technological University (ERI@N). The funding for the research from KSU and ERI@N is very much gratefully acknowledged by the authors. The authors also gratefully acknowledge the contribution of our research engineer Darryl Andriyan Putra on the TRNSYS simulation work in this project.

REFERENCES

- [1] Baek, N.C., Shin, U.C., & Yoon, J.H. (2005). A Study on the Design and Analysis of a Heat Pump Heating System Using Wastewater as a Heat Source. *Solar Energy*, 78, 427-440.
- [2] Chen, C., Sun, F.L., Feng, L., & Liu, M. (2005). Underground Water-Source Loop Heat-Pump Air-Conditioning System Applied in a Residential Building in Beijing. *Applied Energy*, 82(4), 331-344.
- [3] Hall, F. (1982). *Plumbing and Heating Calculations*. New York, USA: Longman.
- [4] Lim, K.B., Lee, S.H., & Lee, C.H. (2009). Application of Ground-Heat-Source Water Thermal-Storage with a Heat-Pump Cooling and Heating System. *Proceedings of I. Mech. E.*, 224, 73-78.
- [5] Liu, G., Meng, D., Li, X., Wang, S., & Song, W. (2010). Study on Operation Performance and Energy-Saving Character of Ground-Source Heat Pump Air-conditioning System. *Proceedings of 2nd International Conference on Computer Engineering and Technology*, 3, 676-679.
- [6] Osman, K., Al-Khairy, S.M.N., Ariffin, M.K., & Senawi, M.Y. (2008). Dynamic Modeling of Stratification for Chilled Water Storage Tank. *Energy Conversion and Management*, 49(11), 3270-3273.
- [7] Zhang, H. F., Ge, X.S., & Ye, H. (2007). Modeling of a Space Heating and Cooling System with Seasonal Energy Storage. *Energy*, 32(1), 51-58.