

An Experimental Study on Heat Transfer and Entropy Generation in Circular Tube Fitted with Trapezium-Nozzles

E. Ibrahim^[a]; E. El-Kashif^[b],*

^[a]Mechanical Power Dept., Faculty of Engineering, Zagazig University, Zagazig 44519, Egypt.

^[b]Mechanical Design and Production Dept., Faculty of Engineering, Cairo University, Giza, Egypt.

*Corresponding author.

Received 1 April 2012; accepted 30 May 2012

Abstract

Heat transfer, friction factor and entropy generation from the inside surface of a horizontal circular tube fitted with trapezium - nozzle have been investigated experimentally. The heat transfer test section is heated electrically imposing axially and circumferentially constant wall heat flux. Three different pitch ratios (PR) of trapezium -nozzle arrangements in the test tube are introduced with PR=2, 4, and 7. The experiments covered a range of Reynolds numbers from 8000 to16000. Heat transfer and friction factor analyses are presented for different conditions of pitch ratios (PR) and Reynolds number. The results indicate that the trapezium - nozzle of different pitch ratios has a great effect on the results of heat transfer coefficient and friction factor. The Nusslet number increases with an increase in Reynolds number and it decreases with an increase in pitch ratios. It is found that using the trapezium -nozzle results in increasing the heat transfer rate compared with the plain tube. The maximum gain in Nusslet number is obtained for the smallest pitch ratio used, PR=2. This indicates that the effect of the reverse/re-circulation and surface flows can improve the heat transfer rate in the circular tube. For fixed Reynolds number, the friction factor increases with the decrease in pitch ratio for the circular tubes with trapezium -nozzle. The entropy generation number increases with increase Reynolds number at all cases, whereas the entropy generation number shows its highest value at pitch ratio of 2. From these results, it was found that the average enhancement in Nusselt number for circular tube fitted with trapezium - nozzle at pitch ratio (PR=2) is in the

range of 202% to 257% compared with the plain circular tube for all tested conditions. Correlations of the Nusselt number and friction factor with Reynolds number and pitch ratio are presented.

Key words: Enhancement heat transfer; Circular tube; Re-circulation/Reverse flow; Turbulator; Entropy generation; Trapezium –nozzle

Ibrahim, E., & El-Kashif, E. (2012). An Experimental Study on Heat Transfer and Entropy Generation in Circular Tube Fitted with Trapezium-Nozzles. *Energy Science and Technology*, 3(2), 74-83. Available from: URL: <http://www.cscanada.net/index.php/est/article/view/10.3968/j.est.1923847920120302.428> DOI: <http://dx.doi.org/10.3968/j.est.1923847920120302.428>

NOMENCLATURE

A : Heat transfer surface area, m²
 Cp : Specific heat of air, J/kg K
 Di : Inside diameter of the test tube, m
 f : Friction factor
 h : Heat transfer coefficient, W/m² K
 I : Current, A
 k : Thermal conductivity of air, W/m K
 L : Length of the test section, m
 l : Pitch length of the trapezium -nozzle arrangement, m
 m : Mass flow rate, kg/s
 Nu : Nusselt number
 N_{ST}: Entropy generation number due to heat transfer rate.
 N_{SP}: Entropy generation number due to pressure drop.
 N_S: Entropy generation number
 ΔP : Pressure drop, Pa
 PR : Pitch ratio (l/d)
 Q : Heat transfer rate, W
 q : heat transfer rate per unit length, W/m
 Re : Reynolds number
 t : Temperature, °C

\bar{t} : Mean temperature, °C
 U : Average axial velocity inside the test section, m/s
 V : Voltage, V
 ν : Kinematics viscosity, m²/s
 ρ : Density, kg/m³

SUBSCRIPTS

a : air
c : convection
i : inlet
o : outlet
w : wall

INTRODUCTION

The need of high-performance thermal systems in engineering applications has stimulated interest in finding ways to increase heat transfer rate in the systems. The conventional heat exchangers can be generally improved by means of various enhancement techniques with several types of enhanced surfaces. The choice of an enhancement technique depends on variables such as: the flow regime (Reynolds number), the fluid properties (Prandtl number), and the existence or not of fouling, the allowable pressure drop and the existence or absence of natural convection. The enhanced surfaces can create one or more combinations of the following conditions favorable for the increase in heat transfer rate with an undesirable rise of friction: (1) interruption of thermal boundary layer development and increase in turbulence intensity, (2) increase in heat transfer area, and (3) generating of swirling and/or secondary flows. So far, many investigations have been focused on passive heat transfer enhancement methods and the fluid flow. Reverse/swirl flow devices form an important group of the passive augmentation technique. The reverse flow, sometimes called “re-circulation flow”, device or the turbulator is widely applied to heat exchanger applications over the past decades; for example, refrigeration, automotives, process industry, solar water heater, etc., while the reduction in overall resistance can lead to a smaller heat exchanger.

Up to date, there have been a large number of attempts to reduce the size and costs of heat exchangers^[1, 2]. Research in this area has captivated the interest of a number of researchers, e.g. Eiamsa and Promvonge^[3]. In the passive technique, improvement is acquired without providing any extra flow energy. In the compound technique, two or more of active or passive techniques may be utilized simultaneously to produce an enhancement that is much higher than that of the techniques operating separately as presented by Yilmaz et al^[4 and 5]. Mamer and Bergles^[6-8] have reported experimental data for laminar flows of ethylene glycol with a twisted-tap ($\gamma=5.39$) in an isothermal tube. Mangilk and

Bergles^[9-11] developed generalized Nusslet number and friction factor correlations. Local convective-condensation measurements for four refrigerant fluids: R134a, R410A, R125 and R32 in a micro-fin tube were presented by kedzierski and Goncalves^[12]. This research showed that R32 exhibit the highest heat transfer performance due to its high thermal conductivity. The turbulent mixed convection in a horizontal circular tube provided with inserted strip has been studied by Hsieh et al^[13]. Yakut and Sahin^[14, 15] used conical-ring turbulators inserted inside the tube to produce reverse/turbulent flows in each module of the conical rings. Therefore heat transfer was improved along the tube wall. For using combined/compound turbulators, Promvonge and Eiamsa-ard^[16-18] experimentally investigated the effect of various nozzles together with a snail type swirl generator (decaying swirl) on heat transfer and friction characteristics in uniform heat flux tube and found that the heat transfer rate increases considerably for using both enhancement devices and it was about 20–50% larger than the single enhancement device (decaying swirl).

The influence of combined conical ring and twisted tape inserts in a round tube on heat transfer and friction behaviors was examined by Promvonge and Eiamsaard^[19]. They presented the significant increase in heat transfer rate and friction factor values over the smooth tube. In addition, Promvonge^[20, 21] also studied experimentally the thermal behaviors of using coiled wire turbulator in common with snail type/twisted tape swirl generator for generating vortex flows and reported that the compound turbulators provide higher heat transfer rate than the single turbulator. However, the use of combined nozzle/ coil turbulators and snail type swirl generators as mentioned earlier was found to suffer from a substantial increase in the pressure loss.

Effects of combined ribs and winglet type vortex generators (WVGs) on forced convection heat transfer and friction loss behaviors for turbulent airflow through a constant heat flux channel are experimentally investigated by Promvonge et al^[22]. The experimental results show a significant effect for the presence of the rib turbulator and the WVGs on the heat transfer rate and friction loss over the smooth wall channel. The values of Nusselt number and friction factor for utilizing both the rib and the WVGs are found to be considerably higher than those for using the rib or the WVGs alone. The effects of V-nozzle inserts on heat transfer and friction characteristics in a uniform heat flux tube are experimentally studied by Eiamsa-ard and Promvonge^[23]. Three different pitch ratios (PR) of V-nozzle arrangements in the test tube are introduced with PR=2, 4, and 7, in each run. The results of experimental investigations of heat transfer and friction characteristic are presented. It is found that using the V-nozzle can help to increase considerably the heat transfer rate at about 270% over the plain tube.

Heat transfer in flat tubes by means of helical screw-tape inserts studied by Ibrahim^[24]. The study shows that the Nusslet number (Nu) and friction factor (f) decrease with the increase of spacer length or twist ratio for flat tube. Heat transfer and pressure drop in trapezoidal micro channels with a 54.7° sidewall angle and with three heated walls were experimentally investigated by Qu et al.^[25,26], who obtained good agreement with theory when an adjusted coolant viscosity was included to account for surface roughness of the channels. Rahman and Shevade^[27] studied experimentally and numerically the flow in trapezoidal micro channels with heating on all four walls, and concluded that the effects of thermal boundary layer development were significant. Wu^[28] and Cheng^[29] experimentally investigated both friction factors and heat transfer in trapezoidal micro channels, while considering the effects of other parameters such as surface conditions. They found that channel geometry had a much more significant effect on the Nusselt number than did roughness or hydrophilicity of the wall surfaces. Correlations fit to their data did not explicitly include the effects of dimensionless length. Sadasivam et al.^[30] provided correlations for Nusselt numbers and friction factors under fully developed conditions in trapezoidal and hexagonal ducts with sidewalls at 30°, 45°, 60°, and 75° based on finite-difference dimensionless.

The importance of rib shape effects on the local heat transfer and flow friction characteristics of square ducts with ribbed internal surfaces was studied by Kamali and Binesh^[31]. The results showed that features of the inter-rib distribution of the heat transfer coefficient are strongly affected by the rib shape and trapezoidal ribs with decreasing height in the flow direction providing higher heat transfer enhancement and pressure drop than other shapes. Heat transfer in the thermal entrance region of trapezoidal micro channels is investigated by John et al^[32]. Three-dimensional numerical simulations were performed using a finite-volume approach for trapezoidal channels with a wide range of aspect ratios. Local and average Nusselt numbers are reported as a function of dimensionless length and aspect ratio. The fully developed friction factors are computed and correlated as a function of channel aspect ratio.

The literature review cited above indicates that both enhancement devices, the trapezium -nozzle turbulators and the vortex generator are among the most effective and practical methods for augmenting heat transfer in ducts. Thus, the main aim of the present work is to investigate the heat transfer and flow friction characteristics in a circular duct equipped with the trapezium -nozzle turbulators where the trapezium -nozzle generates recirculation/reverse flow. Forced convection in a circular tube with trapezium -nozzle under constant wall heat flux is analyzed based on the minimal entropy generation principal. All experiments are carried out at the same inlet

conditions with the Reynolds number range of 8000 to 16000. Subsequently, three kinds of turbulence promoters (PR=2, 4, and 7) were inserted in a circular tube. Also, correlations based on the data obtained during this work for predicting the heat transfer coefficient and friction factor for the circular tube with trapezium -nozzle inserted were proposed for practical applications.

1. EXPERIMENTAL APPARATUS

The experiments were performed in an open-circuit, suction-type air wind tunnel as shown from Fig. 1. The test section is specially designed and fabricated for holding the tested circular tubes. The outer surface of the circular tube is covered with an electric insulating tape on which nickel-chrome wire of 0.4 mm was uniformly wounded to form the main heater as shown in Fig. 2. The main heater is covered with an asbestos layer of 55 mm thickness, on which another nickel-chrome wire of 0.4 mm was uniformly wounded to form a guard heater. The Guard heater is covered with a 40 mm thick asbestos layer. Two pairs of thermocouples are installed in the asbestos layer between the main heater and the guard heater. The thermocouples of each pair are fixed on the same radial line. The input to the guard heater is adjusted so that, at the steady state, the readings of the thermocouples of each pair became practically the same. Then all the heat generated by the main heater is flowing inward to the circular tube. The terminals of the wire are connected to a variac AC transformer, which is used to vary the voltage of the AC current passing through the heating coil. The test-section is circular tube and made of copper having 50.5 mm outer diameter (Do) and 47.5 mm inner diameter (Di) and 1250 mm length (L) as shown in Fig. 3 and this figure represent the trapezium -nozzle arrangement used in the present work. The trapezium -nozzles and the test tube are shown in Figs. 4 and 5 respectively. The nozzles were made of copper and placed with three different pitch lengths, P of arrangements, having $P=95$ mm (PR=2), $P=190$ mm (PR=4), and $P=332.5$ mm (PR=7), for the three experiments done. The nozzles were separated by copper tubes having an outer diameter of 47.5 mm and inner diameter of 46 mm. These tubes will be inserted in the copper tube having an outer diameter of 50.5 mm to adjust the PR among nozzles for the three experiments done as shown in Fig. 5. The inner and outer temperatures of the bulk air were measured at certain points with a multi-channel temperature measurement unit in conjunction with the thermocouple type K. Twenty thermocouples were tapped on the local wall of the tube and the thermocouples were placed around the tube to measure the circumferential temperature variation. The mean local wall temperature was determined by means of calculations based on the reading of type-K thermocouples. The inlet velocity was adjusted using a

discharge damper located at the exit of the fan. The inlet mean velocity in the wind tunnel is measured by using a calibrated Pitot tube. The measurements were taken

at steady state conditions. This was achieved when the differences in the measured temperatures don't exceed 0.2 C.

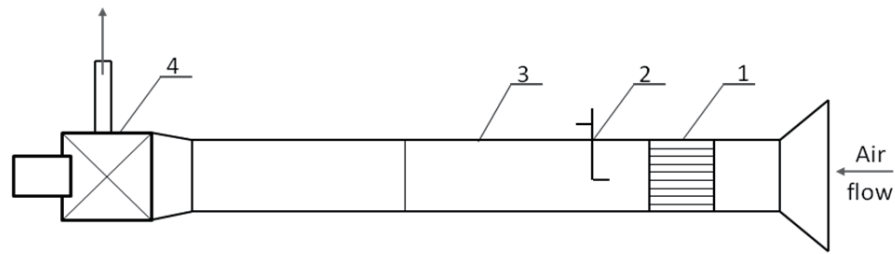

1. Honeycomb 2. Pitot tube 3. Tested circular tube 4. Centrifugal Fan

Figure 1
Experimental Set up

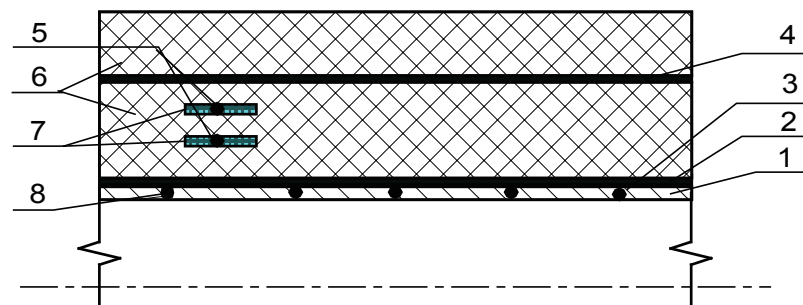

1. Circular tube 2. Main heater 3. Electric insulation
 4. Guard heater 5. Pair of Thermocouples 6. Asbestos layers
 7. Aluminum strips 8. Thermocouples

Figure 2
Heaters Arrangement

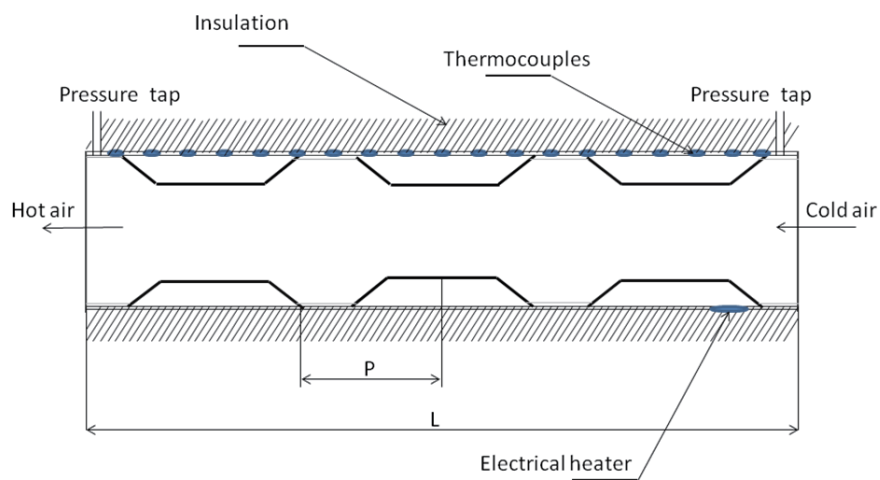

Figure 3
Test Tube Fitted with Trapezium-Nozzle Turbulators

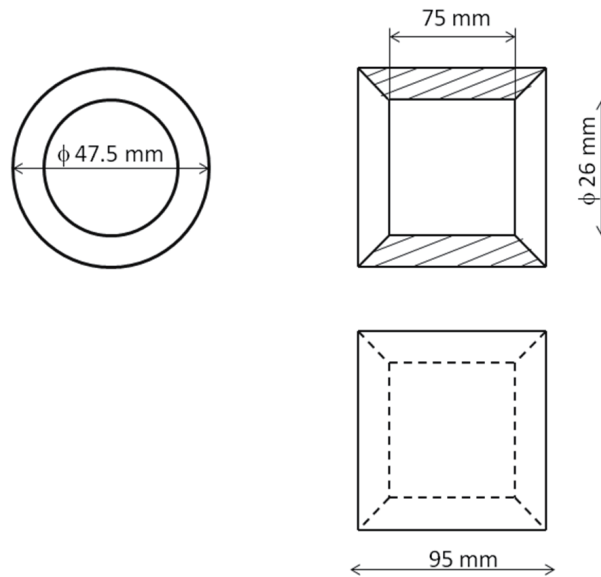

Figure 4
Dimensions of Trapezium-Nozzle/mm

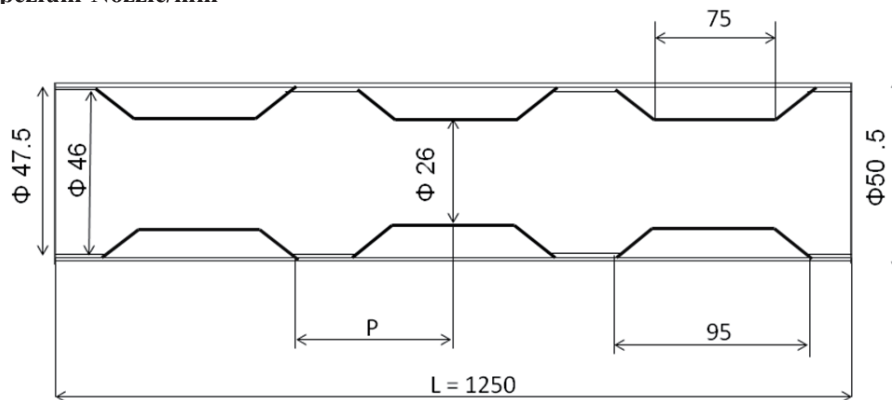

Figure 5
Dimensions of Test-Tube/mm

2. UNCERTAINTY ANALYSIS

Generally, the accuracy of the experimental results depends upon the accuracy of the individual measuring instruments and the manufacture accuracy of the circular tube. Also, the accuracy of an instrument is limited by its minimum division (its sensitivity). In the present work, the uncertainties in Nusselt number (Nu), Reynolds number (Re) and friction factor (f) are estimated according to the differential approximation method. The uncertainty in the data calculation was based on Ref. [33]. For a typical experiment the total uncertainty in measuring the main heater input power, surface temperature, heat transfer rate and circular tube surface area are $\pm 0.2\%$, $\pm 0.55\%$, $\pm 2.2\%$ and $\pm 1.8\%$, respectively. These are combined to give maximum errors of $\pm 2.86\%$, $\pm 4.1\%$, 2.28% and 3.56% in heat transfer coefficient (Nusselt number), Reynolds number and Friction factor (f), respectively.

3. DATA REDUCTION

In the present work, air is used as the tested fluid and flowed through a uniform heat flux-insulated tube. The steady state of the heat transfer rate assumed to be equal to the heat loss from the test section, which can be expressed as:

$$Q_a = Q_c \quad (1)$$

Where:

$$Q_a = m C_{p,a} (t_o - t_i) = VI \quad (2)$$

The heat supplied by the electrical winding in the test tube is found to be 5–8% higher than the heat absorbed by the fluid for the thermal equilibrium test due to convection and radiation heat losses from the test section to the surroundings. Thus, only the heat transfer rate absorbed by the fluid taken for the internal convective heat transfer coefficient. The rate of heat transfer coefficient from the

test section is calculated as:

$$h_c = Q_a / A(\tilde{t}_w - t_a) \quad (3)$$

Where:

$$t_a = (t_o + t_i)/2 \quad (4)$$

$$\tilde{t}_w = \Sigma t_w / 20 \quad (5)$$

Where: t_w is the local surface temperature at the outer wall of the inner tube. The average surface temperature \tilde{t}_w calculated from 20 points of t_w lined between the inlet and the exit of the test tube.

The average Nusselt number, Nu estimated as follows:

$$Nu = h_c D_{eq} / k \quad (6)$$

The Reynolds number of the air flow inside the tube is given as

$$Re = U D_{eq} / \nu \quad (7)$$

The friction factor, can be written as

$$f = \Delta P / [(L / D_i)(\rho U^2 / 2)] \quad (8)$$

Where U is mean air velocity in the tube. All the thermo-physical properties of the air are determined at the overall bulk air temperature from Eq. (4).

The present study focuses on steady, fully developed convection in the trapezium - nozzle with constant wall heat flux. The entropy generation analysis, which is similar to that derived by Bejan^[34] for a straight pipe with circular cross section, has been derived in the study of Ko

and Ting^[35]. The relationship between the friction factor f and pressure drop, and the heat transfer coefficient and Nusselt number, S_{gen} can be expressed by:

$$S_{gen} = [q^2 / ((T^2 \pi Nu k) + T q)] + [m^3 f / (T \rho^2 \pi^2 (D_i / 2)^5)] \quad (9)$$

Where m, q and S_{gen} are the mass flow rate in the circular tube, the heat transfer rate and entropy generation rate per unit coil length, respectively. The only difference between the final form and the derivation of Bejan^[34] is that the entropy generation number N_s defined as $N_s = S_{gen} / (q/T)$ can be obtained from Eq. (9) as

$$N_s = N_{ST} + N_{SP} \quad (10)$$

Where N_{ST} and N_{SP} represent the contribution of entropy generation from heat transfer and fluid friction respectively.

4. RESULTS AND DISCUSSIONS

The heat transfer and friction of the plain tube performed by comparing with previous correlations from the literature^[33] under similar conditions is shown in Figs. 6 and 7, respectively. The circular plain tube data was found to be in good agreement with the previous correlations for Nusselt number and friction factor of Dittos–Boelter and Petukhov^[33], for both the Nusselt number and the friction factor within $\pm 6\%$ and 10 % respectively.

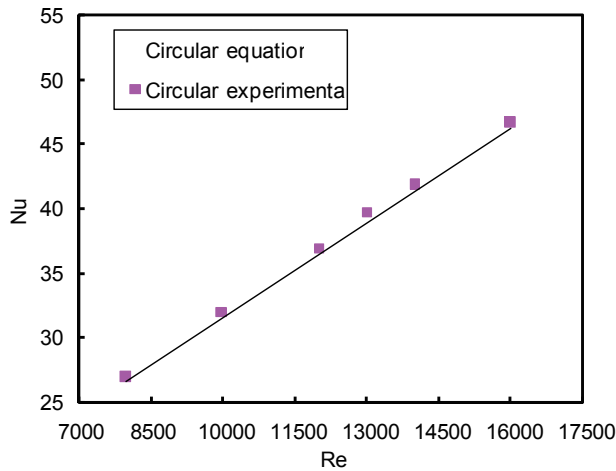

Figure 6
Comparison Between the Present Results of Nu–Re with that of Dittus and Boelter^[32]

Nusselt number correlations:

Correlation of Dittus–Boelter,

$$Nu = 0.023 Re^{4/5} Pr^{0.4} \text{ for } Re \geq 10^6 \quad (11)$$

Friction factor correlations:

Correlation of Petukhov,

$$f = (0.79 \ln Re - 1.64)^{-2} \text{ for } 3000 \leq Re \leq 5 \times 10^6 \quad (12)$$

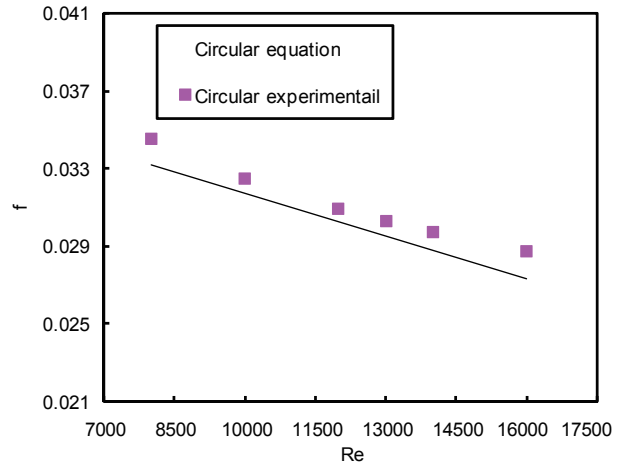

Figure 7
Comparison Between the Present Results of f –Re with that of Petukhov^[32]

The present results for circular tube are correlated with the Nusselt number and friction factor for the plain tube as follows:

$$Nu = 0.021 Re^{0.794} \quad (13)$$

$$f = 0.38 Re^{-0.267} \quad (14)$$

$$\text{For } 8000 \leq Re \leq 16000$$

Figure 8 shows the variation of Nusselt number with Reynolds number for the circular tube equipped with various pitch ratios of trapezium -nozzles compared with plain circular tube in a uniform heat flux. For all cases, the Nusselt number increases with increasing Reynolds number. This is may be attributed to the increase of turbulent intensity as Reynolds number increases, leading to an amplification of convective heat transfer. At the given Reynolds number, the Nusselt numbers for the tube with trapezium–nozzles are considerably higher than those for the plain tube. The increase in heat transfer rate with reducing pitch ratio is due to the higher turbulent intensity

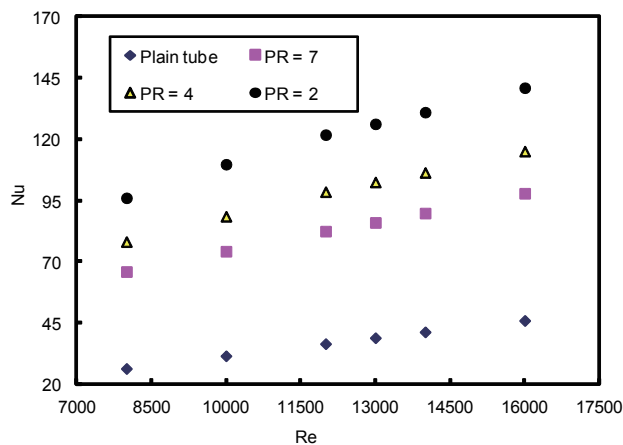

Figure 8
Variation of Nusselt Number with Reynolds Number

The variations between the friction factor (f) and with Reynolds number are presented in Fig. 9. The friction factors tend to decrease with the increase of Reynolds number. The use of tube with trapezium-nozzles leads to high friction factor over that of the plain tube. This increase in friction factor may be due to reverse/turbulent flow. This is because of the dissipation of dynamic pressure of the fluid due to higher surface area and the effect caused by the reverse flow. Moreover, the pressure drop has the high possibility to occur by the interaction of the pressure forces with inertial forces in the boundary layer. The three different pitch ratios of the trapezoidal used generate higher friction factors than plain circular tubes. The friction factors in the tubes with trapezium-

imparted to the flow between the trapeziums-nozzles. For the lowest pitch ratio (PR=2), the increase in heat transfer rate is in a range of 202% to 257%, while at the pitch ratios of PR=4 and PR=7, the increase in heat transfer rate is in the range of 147% to 190% and 110% to 145% respectively over the plain tube for the Reynolds number ranging from 8000 to 18000. This may be attributed to a better mixing of the fluid between the core and the tube surface regions from turbulent fluctuation or eddy motion and the appearance of reverse flow between the trapezium-nozzle elements, leading to higher temperature gradients.

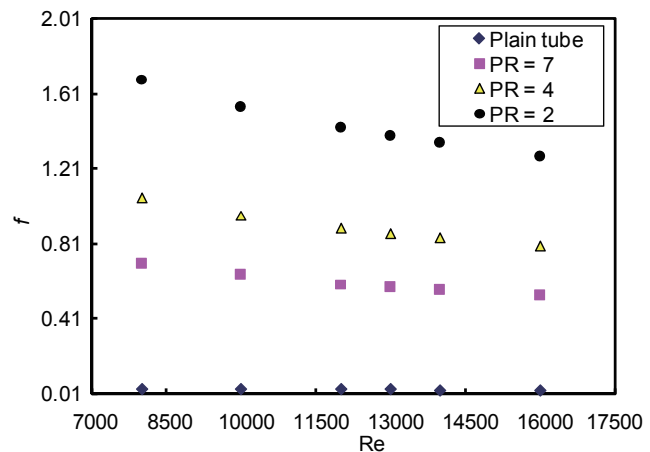

Figure 9
Variation of Friction Factor with Reynolds Number

nozzles are about 17, 27 and 44 times of those in the plain tube at the three pitch ratios used respectively.

The variation of Nu_t/Nu_s with Reynolds numbers at various trapezium-nozzle is shown in Fig.10. It can be shown that the ratio of Nu_t/Nu_s shows the highest value at pitch ratio of 2. Also as seen from this figure, the ratio of Nu_t/Nu_s tends to decrease with the rise of Reynolds number, for all cases. This suggests that trapezium -nozzle turbulators are not feasible in terms of energy saving at higher Reynolds numbers. The ratio of Nu_t/Nu_s varies from 3 to 3.57 for PR = 2; 2.47 to 2.9 for PR= 4 and 2 to 2.45 for PR= 7. Also, it is clear from fig.10 that the best heat transfer achieved was obtained at the pitch ratio of 2.

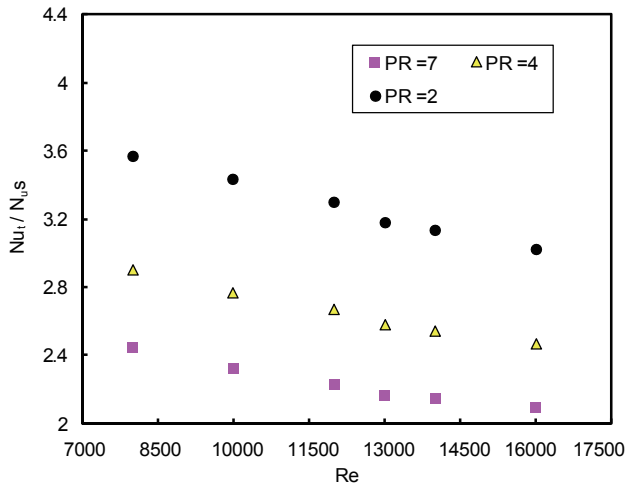

Figure 10
 Variation of Nu_i/Nu_s with Reynolds Number

The enhancement in heat transfer will make the temperature gradient in the direction of flow fields and as a result, the irreversibility due to heat transfer will be greatly reduced. This explains why N_{ST} decreases with the increase of Re . On the contrary, fluid friction increases as Re becomes larger, which results in the increase of frictional irreversibility and thus causes the increase of N_{SP} and as a result the entropy generation number will be increased as well. The entropy generation number is the sum of the N_{ST} and N_{SP} . Figure 11 indicates that N_s increases with the increase of Re at all cases. In addition, this figure also reveals an important fact that the entropy generation number in the flow field increases with large pitch ratio. This explains that the friction increases as the pitch ratio increases; also, this figure shows that the

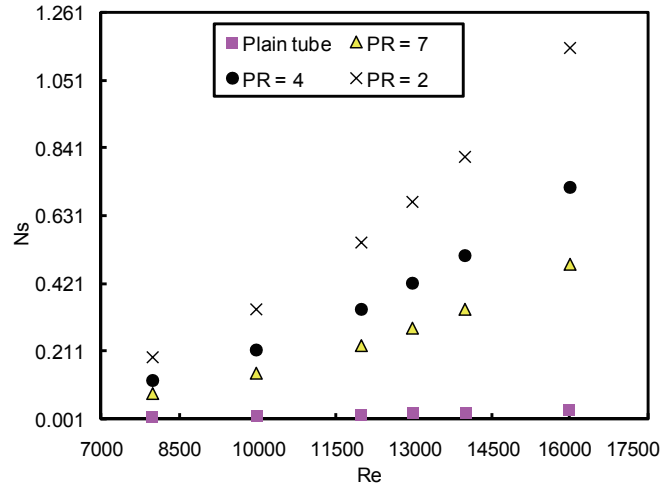

Figure 11
 Variation of N_s with Reynolds Number

entropy generation number at all pitch ratios has larger values than plain tube.

5. COMPARISON WITH THE PREVIOUS WORK

Comparison between the Nusselt numbers and friction factor obtained from the present measurement with reference [23] are shown in Figs 12 and 13. In these figures, the Nusslet number and friction factor for circular tube with trapezium - nozzle are higher than circular tube with V- nozzle at $PR = 2$, where the increase in heat transfer rate and friction factor are in the range of 14% to 17% and 9.8% to 11.2% respectively.

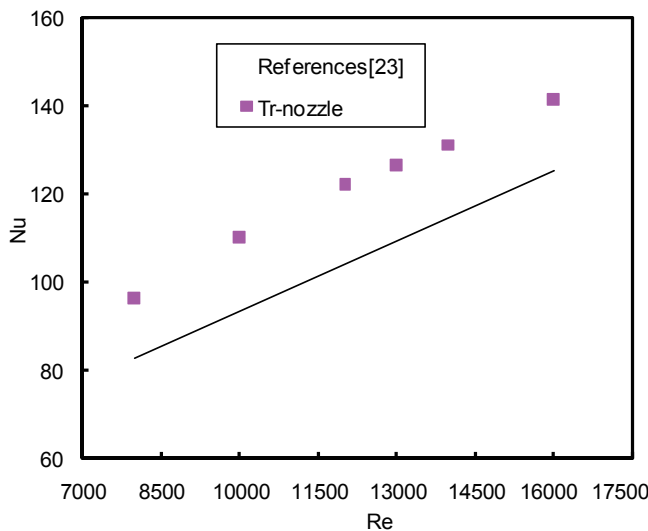

Figure 12
 Comparison Between Trapeziums (Tr)-Nozzle with Reference [23] at Pitch Ratio 2

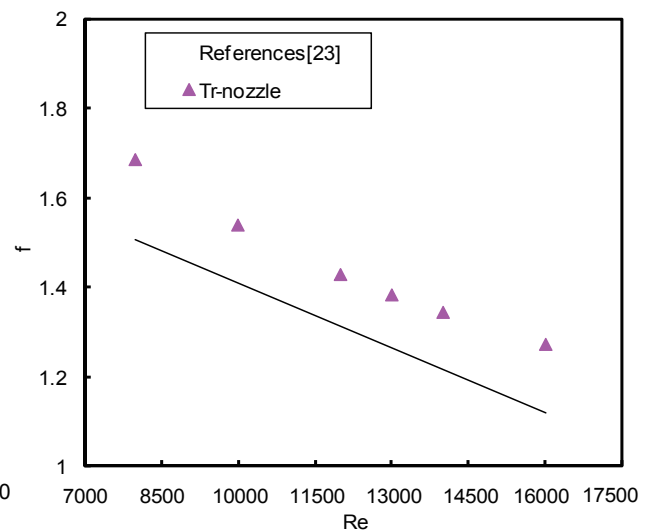

Figure 13
 Comparison Between Trapeziums (Tr)-Nozzle with Reference [23] at Pitch Ratio 2

6. CORRELATION OF THE RESULTS

The general correlation of the Nu as a function of Re and PR of the experimental results are expressed as the following:

$$Nu = a Re^b (PR)^c \quad (15)$$

The experimental data is fitted to get the constants and the following correlation could be obtained:

Circular tube with trapezium-nozzle

$$Nu = 0.796 Re^{0.557} (PR)^{-0.304} \quad (16)$$

$$8000 \leq Re \leq 16000 \quad \text{and} \quad 2 \leq PR \leq 7$$

The general correlation of the f as a function of Re and PR of the experimental results is expressed as following:

$$f = c Re^m (PR)^n \quad (17)$$

The experimental data is fitted to get the constants and the following correlation can be obtained:

Circular tube with trapezium -nozzle

$$f = 103.91 Re^{-0.404} (PR)^{-0.699} \quad (18)$$

$$8000 \leq Re \leq 16000 \quad \text{and} \quad 2 \leq PR \leq 7$$

The calculated Nusselt number Nu_{cal} and f_{cal} from Eq. (16, and 18) is plotted versus experimental Nusselt number Nu_{exp} and f_{cal} in figures 14 and 15. As shown from these figures, the maximum deviation between the experimental data and the correlation is 5% and 3% respectively.

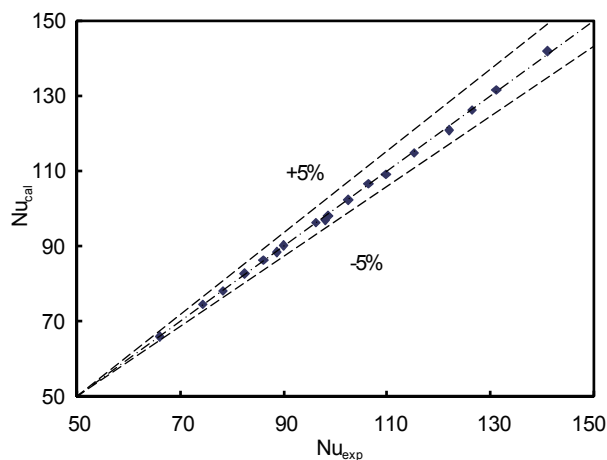

Figure 14
Nu_{cal} Against Nu_{exp}

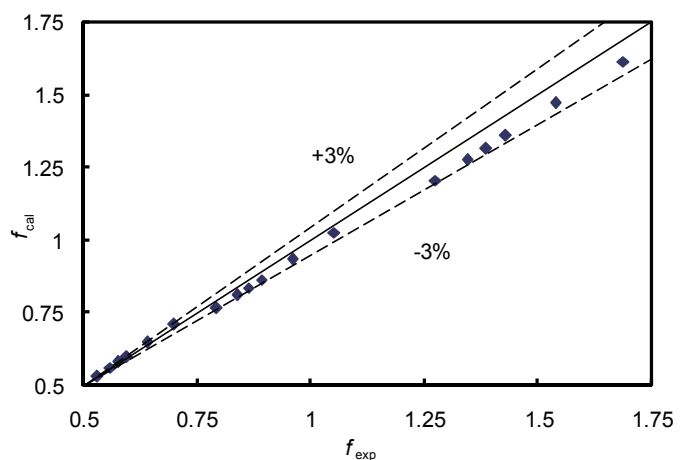

Figure 15
 f_{cal} Against f_{exp}

CONCLUDING REMARKS

The experimental results of heat transfer and friction characteristics in a uniform heat flux tube with trapezium-nozzle inserted circular tube have been reported. The effect of the pitch ratio with trapezium-nozzle on the heat transfer and friction characteristics within the range of Reynolds number from 8000 to 16000 has been investigated. The tube was heated by continuous winding flexible electrical wire to provide a uniform heat flux boundary condition and three different pitch ratios (PR = 2, 4 and 7) were used. The following conclusions were derived:

For all cases, Nusselt number increases and friction factor decreases with increasing Reynolds number. The highest Nusselt number and friction factor is obtained for pitch ratio of 2.

The mean heat transfer rates obtained from using the trapezium -nozzles at PR=7, 4 and 2 are found to be in the range of 110 to 145%, 147 to 149%, and 202 to 257% respectively than the plain tube.

The entropy generation number increases with the increase in Reynolds number at all cases and shows the highest value at the pitch ratio of 2.

Correlations for the Nusselt number and the friction factor based on the experimental data introduced for practical use.

REFERENCES

- [1] Bergles A., & Webb, R. (1985). Guide to the Literature on Convection Heat Transfer Augmentation. *Advances in Enhanced Heat Transfer*, 43, 81–89.
- [2] Marnar, W., Bergles, A., & Chenoweth, J. (1983). On the Presentation of Performance Data for Enhanced Tubes Used in Shell and Tube Heat Exchangers. *Transaction ASME, Journal Heat Transfer*, 105, 358–365.
- [3] Eiamsa-ard, S., & Promvong, P. (2005). Enhancement of Heat Transfer in a Tube with Regularly-Spaced Helical Tap Swirl Generators. *Solar Energy*, 78, 483-494.
- [4] Yilmaz, M., Comakli, O., Yapici, S., & Sara O. (2003). Heat Transfer and Friction Characteristics in Decaying Swirl Flow Generated by Different Radial Guide Vane Swirl Generators. *Energy Converse Management*, 44(2), 283-300.
- [5] Yilmaz, M., Comakli, O., & Yapici, S. (1999). Enhancement of Heat Transfer by Turbulent Decaying

- Swirl Flow. *Energy Converse Management*, 40(13), 1365-1376.
- [6] Marner, W., & Bergles, A. (1978). Augmentation of Tube Side Laminar Flow Heat Transfer by Means of Twisted-Tap Inserts. *Static Mixer Inserts and Internally Finned Tubes. J. Illum. Eng. Soc. Aug.7-11.Natl Res. Council. of Can.*
- [7] Marner, W., & Bergles, A. (1985). Augmentation of Highly Viscous Laminar Tube Side Heat Transfer by Means of a Heat Twisted-Tap Insert and an Internally Finned Tubes. *ASME.HTD*, 43, 19-28.
- [8] Mamer, W. J., & Bergles, A. E. (1989). Augmentation of Highly Viscous Laminar Heat Transfer Inside Tubes in Constant Wall Temperature. *Experimental Thermal Fluid Science*, 2(3), 252-267.
- [9] Manglik, R., & Bergles, A. (1987). Correlation for Laminar Flow Enhanced Heat Transfer in Uniform Wall Temperature Circular Tubes with Twisted-Tape Inserts. *ASME.HTD.*, 68, 19-25.
- [10] Manglik, R., & Bergles, A. (1993). Heat Transfer and Pressure Drop Correlations for Twisted-Tape Inserts in Isothermal Tubes: Part 1-Laminar Flows. *ASME.J. Heat Transfer*. 115(4), 881-889.
- [11] Manglik, R., & Bergles, A. (1993). Heat Transfer and Pressure Drop Correlations for Twisted-Tape Inserts in Isothermal Tubes: Part II-Transition and Turbulent Flows. *ASME. J. Heat Transfer*, 115(4), 890-896.
- [12] Kedzierski, M., & Goncalves, J. (1999). Horizontal Convective Condensation of Alternative Refrigerants Within a Micro-Fin Tube. *Enhanced Heat Transfer*; 6, 161-178.
- [13] Hsieh, S., Liu M.H., & Wu, F. Y. (1998). Developing Turbulent Mixed Convection in a Horizontal Circular Tube with Strip-Type Inserts. *Int. J. Heat and Mass Transfer*, 41(8-9), 1049-1063.
- [14] Yakut, K., & Sahin, B. (2004). Flow-Induced Vibration Analysis of Conical Rings Used of Heat Transfer Enhancement in Heat Exchanger. *Applied Energy*, 78(3), 273-288.
- [15] Yakut, K., Sahin, B., & Canbazoglu, S. (2004). Performance and Flow-Induced Vibration Characteristics for Conical-Ring Turbulators. *Applied Energy*, 79(1), 65-76.
- [16] Promvong, P., & Eiamsa-ard S. (2007). Heat Transfer Augmentation in a Circular Tube Using V-Nozzle Turbulator Inserts and Snail Entry. *Exp. Therm. Fluid Sci.*, 32(1), 332-40.
- [17] Promvong, P., & Eiamsa-ard, S. (2006). Heat Transfer Enhancement in a Tube with Combined Conical-Nozzle Inserts and Swirl Generator. *Energy Converse. Manage.*, 47(18-19), 2867-82.
- [18] Promvong, P., & Eiamsa-ard, S. (2007). Heat Transfer in a Circular Tube Fitted with Free Spacing Snail Entry and Conical-Nozzle Turbulators. *Int. Commun. Heat Mass Transfer*; 34(7), 838-48.
- [19] Promvong, P., & Eiamsa-ard, S. (2007). Heat Transfer Behaviors in a Tube with Combined Conical-Ring and Twisted-Tape Insert. *Int Commun Heat Mass Transfer*; 34(7), 849-59.
- [20] Promvong, P. (2008). Thermal Augmentation in Circular Tube with Twisted Tape and Wire Coil Turbulators. *Energy Converse. Manage.*, 49(11), 2949-55.
- [21] Promvong, P. (2008). Thermal Enhancement in a Round Tube with Snail Entry and Coiled-Wire Inserts. *Int Commun Heat Mass Transfer*; 35(5), 623-9.
- [22] Promvong, P., Teerapat, C., Sutapat, K., & Chinaruk, T. (2010). Enhanced Heat Transfer in a Triangular Ribbed Channel with Longitudinal Vortex Generators. *Energy Conversion and Management*, 51(6), 1242-1249.
- [23] Eiamsa-ard, S., & Promvong, P. (2006). Experimental Investigation of Heat Transfer and Friction Characteristics in a Circular Tube Fitted with V-Nozzle Turbulators. *International Communications in Heat and Mass Transfer*; 33(5), 591-600.
- [24] Ibrahim, E. (2011). Augmentation of Laminar Flow and Heat Transfer in Flat Tubes by Means of Helical Screw-Tape Inserts. *Energy Conversion and Management*, 52(1), 250-257.
- [25] Qu, W. L., Mala, G. M., & Li, D. Q. (2000). Heat Transfer for Water Flow in Trapezoidal Silicon Micro Channels. *Int. J. Heat Mass Transfer*; 43(21), 3925-3936.
- [26] Qu, W. L., Mala, G. M., & Li, D. (2000). Pressure-Driven Water Flows in Trapezoidal Silicon Micro Channels. *Int. J. Heat Mass Transfer*; 43(3), 353-364.
- [27] Rahman, M., & Shevade, S. (2005). Fluid Flow and Heat Transfer in a Composite Trapezoidal Micro Channel. In: *Proc. 2005 ASME Summer Heat Transfer Conference* (pp. 411-417).
- [28] Wu, H., & Cheng, P. (2003). Friction Factors in Smooth Trapezoidal Silicon Micro Channels with Different Aspect Ratios. *Int. J. Heat Mass Transfer*; 46(14), 2519-2525.
- [29] Wu, H., & Cheng, P. (2003). An Experimental Study of Convective Heat Transfer in Silicon Micro Channels with Different Surface Conditions. *Int. J. Heat Mass Transfer*; 46(14), 2547-2556.
- [30] Sadasivam, R., Manglik, R., & Jog, M. (1999). Fully Developed Forced Convection Through Trapezoidal and Hexagonal Ducts. *Int. J. Heat Mass Transfer*; 42(23), 4321-4331.
- [31] Kamali, R., & Binesh, A. (2008). The Importance of Rib Shape Effects on the Local Heat Transfer and Flow Friction Characteristics of Square Ducts with Ribbed Internal Surfaces. *International Communications in Heat and Mass Transfer*; 35(8), 1032-1040.
- [32] John, P., & Suresh, V. (2010). Heat Transfer in Trapezoidal Micro Channels of Various Aspect Ratios. *International Journal of Heat and Mass Transfer*, 53, 365-37.
- [33] ANSI/ASME. (1986). *Measurement Uncertainty* (PTC 19, pp. 1-1985).
- [34] Bejan, A. (1996). *Entropy Generation Minimization*. Boca Raton, FL: CRC Press.
- [35] Ko, T., & Ting, K. (2005). Entropy Generation and Thermodynamic Optimization of Fully Developed Laminar Convection in a Helical Coil. *Int Commune Heat Mass Transfer*; 32(1-2), 214-23.