

Energy Analysis of a Concentrating Photovoltaic Thermal (CPV/T) System

C. Renno^{[a],*}; F. Petito^[b]

^[a]Associate professor. PhD. Department of Industrial Engineering, University of Salerno, Fisciano (Salerno), Italy.

^[b]PhD. University of Salerno, Fisciano (Salerno), Italy.

*Corresponding author.

Received 30 July 2013; accepted 30 September 2013

Abstract

The potential of the concentrating photovoltaic technology has been evaluated from the thermal point of view in this paper. A model of a concentrating photovoltaic thermal system (CPV/T) was presented in order to size it and to evaluate its energy performance when it is used to satisfy the electric, heating and cooling loads referring to a domestic application. The choice and sizing of the CPV/T system components is first of all considered. The triple-junction cells and the reflective optics with parabolic mirror concentrators of point-focus type assembled with a dual axis tracker, are adopted in order to obtain a high concentration system; an active cooling system of the photovoltaic cells is also considered. The CPV/T system allows recovering thermal energy at high temperature for the absorption heat pump working. The model analyzed the CPV/T system working in terms of: cell efficiency, module electric and thermal efficiency, thermal and electric energy provided by the cell and module, cell and cooling fluid temperatures. So, the simulation process allows realizing an energy analysis and defining the best configuration of the CPV/T system, evaluating its energy convenience in comparison with a traditional system under different working conditions.

Key words: Concentrating photovoltaic; CPV/T system; Domestic application

C. Renno, F. Petito (2013). Energy Analysis of a Concentrating Photovoltaic Thermal (CPV/T) System. *Energy Science and Technology*, 6(2), 53-63. Available from: URL: <http://www.cscanada.net/index.php/est/article/view/10.3968/j.est.1923847920130602.2618>
DOI: <http://dx.doi.org/10.3968/j.est.1923847920130602.2618>

INTRODUCTION

The photovoltaic systems allow obtaining electric energy with competitive costs if compared to traditional systems; in the last years the concentrating photovoltaic systems (CPV) have been greatly developed (Kurtz, 2009; Mokri & Emziane, 2011). In the CPV systems the solar light is concentrated by means of optical devices that allow decreasing the solar cells area proportionally to the concentration factor (C); C is the ratio between the primary concentrator area and that of the solar cell (Zahedi, 2011). A concentration system consists of three parts: receiver, focusing optics and solar tracker. The receiver is the component that includes both the solar cell and the heat dissipation system. The focusing optics allows the sunlight concentration on the receiver. Since the concentration systems work with the sunlight direct component, the receiver and the focusing optics require the use of a single axis or dual axis solar tracker in order to optimize the incident radiation at any moment. About the optics there are two basic solutions. The first is the refractive by means of the Fresnel lenses (Zhai et al., 2010). The second solution considers the parabolic concentrators, consisting essentially of mirrors able to concentrate the radiation on the cells without reproducing the light source image; moreover, a secondary optics could be used to increase the concentration and enhance the radiation focus (Vossier et al., 2012; Brogen, 2004). As for the solar cells use in the last years the triple junction cells are more adopted. They have a voltage-current characteristic which increases logarithmically with the concentration level (Cotal et al., 2009). They are also less influenced by the temperature increase, as the lower percentage decrease of the open circuit voltage shows; hence, efficiencies over 30% are experimentally achieved (Zhai et al., 2010). There are various types of concentration systems, which depend on the type of sunlight focus and receiver, and classified, according to the concentration factor, in plants at low, medium and

high concentration. The advantages obtained with the concentration are evaluated in many studies in terms of electrical performance. In (Brogen, 2004) a low concentration system with parabolic concentrators is discussed. In (Li et al., 2011) the possibility to use arrays of cells with high performance such as GaAs instead of traditional cells is studied, concentrating the light with a linear reflector and adopting heat recovery systems in order to obtain both higher electric performance and thermal energy. The thermal energy can be recovered by the solar cells both by means of active systems using a cooling fluid and with passive cooling systems that use the natural convection mechanism (Zahedi, 2011). An active mechanism of heat transfer is important either to cool the cells or to obtain exploitable thermal energy. In (Kribus et al., 2006) a CPV/T system of small dimensions has been analyzed, based on a parabolic concentrator which reflects the light on a single cell. This system provides a particular mechanism of heat transfer which allows extracting heat from the cells and transfers it to the cooling fluid; the thermal efficiency is about 60% with an electric efficiency higher than 20%. The thermal energy available can be used not only for the heating and sanitary hot water, but also to get cooling. In (Mittelman et al., 2007) a CPV/T system has been linked to a single stage LiBr/H₂O absorption heat pump, realizing so a solar cooling system. It is important to use an apparatus that allows both to chase the solar radiation and the right location of the pipes where the heat transfer fluid flows without occupying too much space (Mousazadeh et al., 2009). In particular, in this paper a model built in Matlab (Matlab R2007b, 2007) is presented in order to evaluate the electric, heating and cooling performances of a CPV/T system usable in a domestic application. A reflective optics with parabolic mirror concentrators of point-focus type and a triple-junction (InGaP/InGaAs/Ge) cell mounted on a dual axis tracker, are used to obtain a high concentration system. A CPV/T system, differently from traditional photovoltaic systems, allows recovering thermal energy at high temperature; hence, a coupling between a CPV/T system and an absorption heat pump (AHP) allows satisfying the cooling demands. The model allows both to size the CPV/T system components, evaluating also the direct normal irradiance, and to compare from the energy point of view the CPV/T system with a traditional system.

1. CPV/T SYSTEM

The CPV/T system (Figure 1) simulated in this paper uses solar energy concentrated to satisfy the different energy demands related to a domestic application. This system uses a reflective optics that consists of small parabolic concentrator mirrors, of point-focus type in order to obtain a high concentration system, that reflect the light on triple-junction cells InGaP/InGaAs/Ge

(Indium-Gallium Phosphide/ Indium-Gallium Arsenide/ Germanium) placed at a certain distance among them on a plate where the cooling fluid flows in pipes suitably sized. The system is completed with a mechanism of dual axis tracker; in particular, in the system considered a rotating frame on which the concentrators are placed to follow the sun, is presented. This frame is then raised or lowered to follow the solar elevation through an actuator. Referring to a domestic application, in order to optimize the space occupied, the CPV/T system is modular and each module consists of 90 cells. Hence, using square cells with side of 9 mm, a concentration level up to 900x is reached and each concentrator is represented by a parabolic surface of area 0.073 m². The calculation of the module total size takes into account the optics used, the cells area and their number, and the concentration factor. Moreover, the cells arrangement that constitute the module is important. After geometric considerations, it has been determined that the module that occupies less space is related to a cells layout of rectangular type, where the cells are positioned on multiple parallel rows, compared to other types of layout (rhomboid, circular, etc...). In order to reduce the number of cells in series and not to affect the module performance, the 90 cells have been arranged in six parallel rows each of which consists of 15 units. In order to calculate the space occupied by each module, it is necessary to know the cell size and the concentration factor in order to determine the concentrator area from which it is possible to evaluate the concentrator side; hence, a side equal to 0.27 m is obtained. Assuming 15 cells in series and a distance between the cells equal to half of the concentrator diameter, the module total length is equal to 5.94 m (Figure 1). The module width, equal to 2.43 m, is calculated in a similar way and takes into account the distances between the six rows in order to allow the tubes mounting of the cooling fluid; hence, the single module occupies a total area of 14.43 m². Related to south Italy sites, the CPV/T system generally consists of two modules which occupy a total area of about 30 m². In Figure 2 a scheme of the CPV/T system, used to meet the energy demands related a domestic application, is shown. The concentrating photovoltaic modules are linked to a tank working as a hot water storage. The mains water is mixed to obtain a glycol solution and reaches the tank where is sent to the CPV/T system for its cooling. In Figure 2 a single stage absorption heat pump (AHP), which receives thermal energy from the CPV/T system for its working, is presented. The scheme presents either a traditional boiler able to integrate thermal energy or an inverter able to convert the direct current obtained by the CPV/T system into alternating current. A grid-connected system is also considered; it is possible to integrate the electricity from the network and to give the surplus energy back to it.

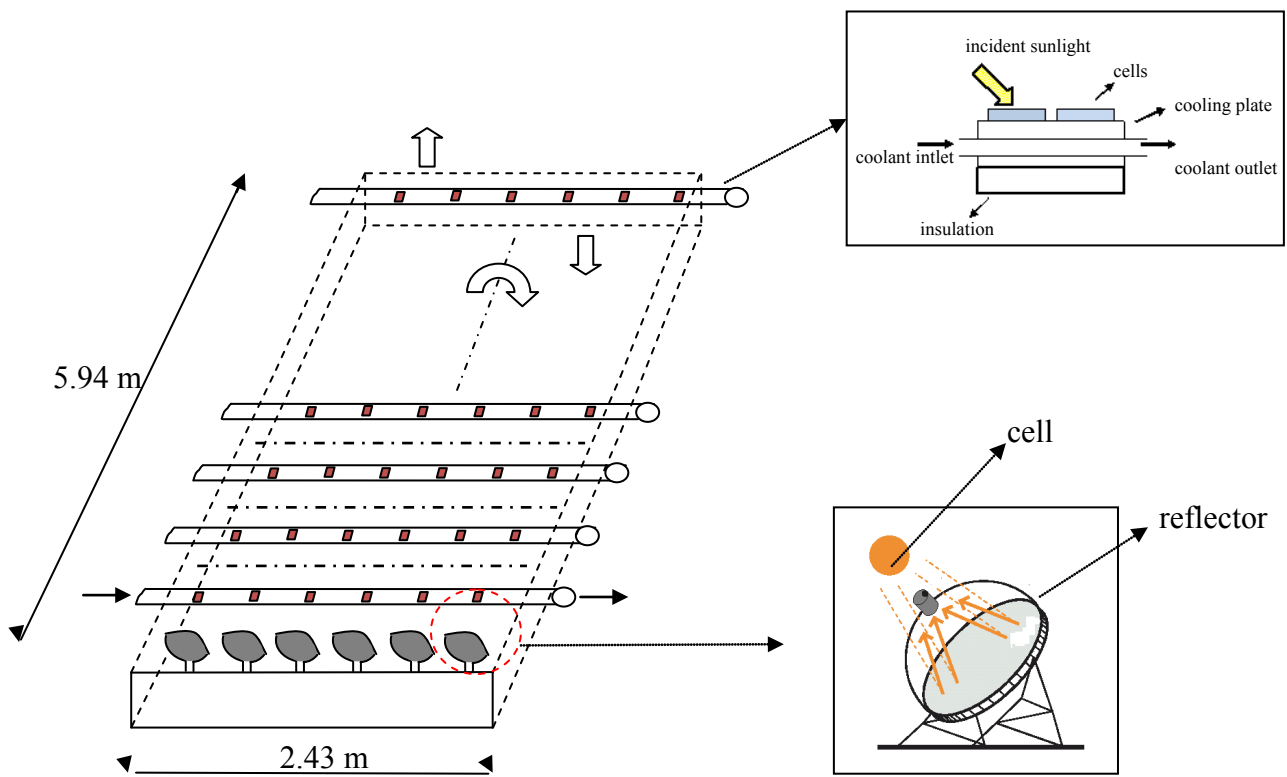

Figure 1
 CPV/T Module

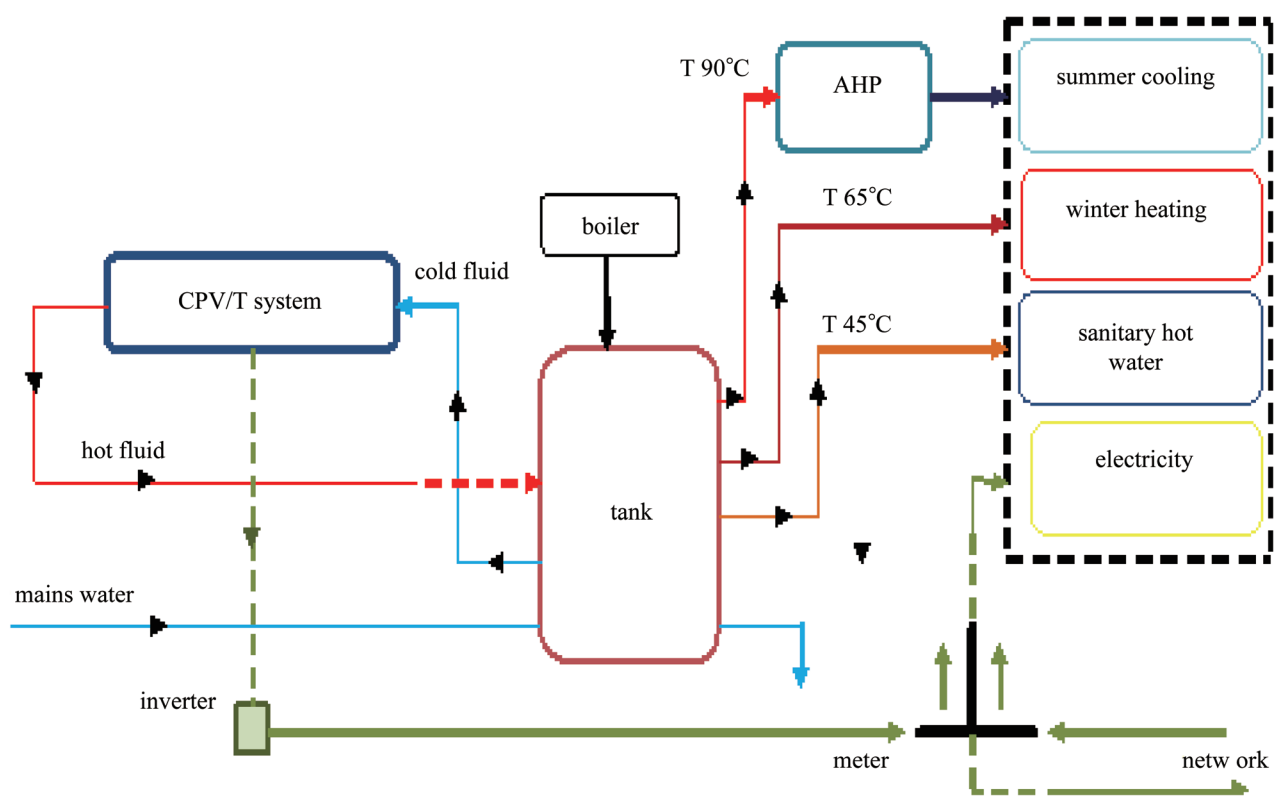

Figure 2
 CPV/T System Linked to a Domestic Application

2. CPV/T SYSTEM MODEL

The model of the CPV/T system described above requires the definition of the main exogenous and endogenous variables. The first are non controllable external variables (solar radiation, atmospheric conditions, environment temperature), but they can be evaluated and parameterized in order to simulate the different working conditions of the CPV/T system. The second represent the system internal variables that characterize its working. In order to analyze the system proposed under various operating conditions,

the main system variables (optics, cell size, concentration factor and loads) have been suitably varied. The CPV/T system model has been realized in Matlab and subdivided into several steps (Figure 3). The first phase analyzes the model input data (optics, cell size, geographic location, etc..). Subsequently the main variables (cell temperature, cell efficiency, etc..) which characterize the CPV/T system working are parameterized, and, finally, the model results (thermal energy, electric energy, module efficiency, etc..) are determined.

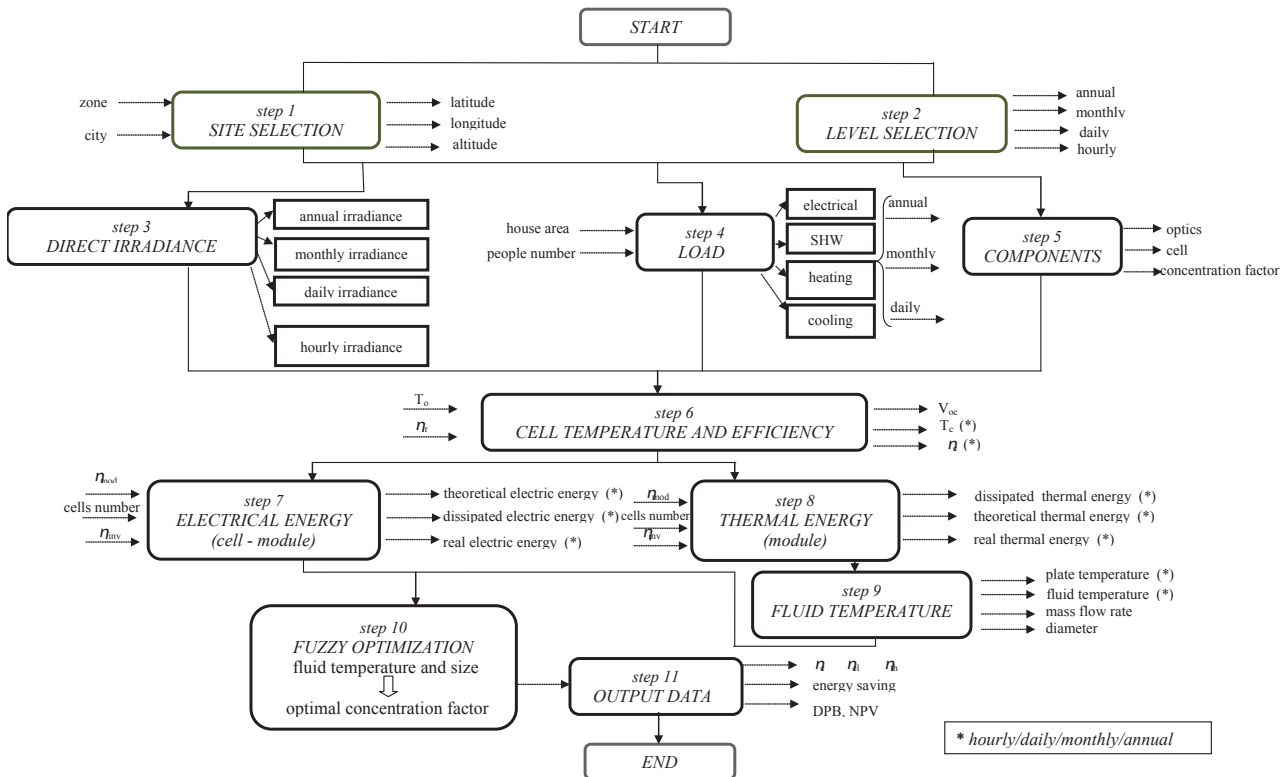

Figure 3
Flow-Chart of the CPV/T System Model

2.1 Model Input Data

It is necessary first of all to determine the site where to install the CPV/T system; latitude, longitude and altitude of several Italian sites (ENEA) have been included in the model.

Moreover, the average values of cloud cover have been considered in the evaluation of the direct normal irradiance (Desiato et al., 2006) and calculated in oktas on a statistical basis of thirty years. Other input data are the optics type adopted and the cells data (area and number) that constitute the single module.

2.2 Direct Normal Irradiance

The direct normal irradiance (DNI) determination is the starting point to realize a correct sizing of the CPV system. For this purpose it is important to consider the main angles in the model necessary to calculate the air mass

and the direct normal irradiance incident on the surface (Technical standard UNI, 1983). Moreover, it is necessary to consider the impact that the weather conditions have on the direct normal irradiance determination differently from the diffuse irradiance. Once known the daily light hours, the total daily irradiance can be evaluated together with the monthly and yearly irradiance. By means of HRA both the solar elevation hour by hour and the zenith angle ($\theta_z = 90^\circ - \alpha$) are defined and represent the input parameters to calculate the air mass (Kasten and Young, 1989):

$$air\ mass = \frac{1}{\cos \theta_z + 0.50572 \cdot (96.07995 - \theta_z)^{-1.6364}} \quad (1)$$

that defines the path of light in the atmosphere compared to the path that it would perform if the sun was at its zenith. Once known the air mass value, the direct normal

irradiance, calculated in a determined hour, can be obtained (Laue, 1970):

$$G_{dir} = G_0 \cdot [(1 - a \times h) \cdot 0.7^{AM^{0.678}} + a \cdot h] \quad (2)$$

The irradiance is calculated knowing the daily light hours that can be obtained through the hour angle of the astronomical sunset (ω_s) (Technical standard UNI). Because at dawn $HRA = -\omega_s$ and at sunset $HRA = \omega_s$ the direct irradiance previously calculated can be changed by means of the cloud cover factor (c_n):

$$G_{dir,r} = G_{dir} \cdot c_n \quad (3)$$

The irradiance thus calculated will take into account the further losses due to the surface inclination also with a tracking system. The Table 1 shows the monthly trend of the direct normal irradiance for several Italian cities.

Table 1
Direct Normal Irradiance

	Direct normal irradiance (kWh/m ²)					
	Milan	Turin	Rome	Florence	Naples	Palermo
January	48	73	75	60	71	67
February	73	84	81	72	75	76
March	118	121	110	100	99	113
April	135	130	131	109	117	138
May	158	139	171	148	154	189
June	183	160	203	176	190	224
July	227	200	255	224	242	268
August	194	165	226	200	218	240
September	152	129	162	148	160	168
October	101	103	123	110	119	115
November	52	71	78	61	76	81
December	46	70	72	51	68	65
Total	1486	1444	1687	1460	1589	1744

2.3 Cell Efficiency And Temperature

The factors evaluation that most influence the working conditions of the CPV/T system are closely interconnected; in fact it is necessary to know the cell temperature to calculate its efficiency. The temperature determination is complex because of the illumination characteristics and the cell construction technology. Although there are not equations that uniquely express the cell temperature in terms of the concentration factor (C), it is possible to refer to some experimental results (Luque et al., 1998). Hence, it is possible to express the cell temperature in this way:

$$T_c = T_o + \frac{V_{oc}(T_c, C) - V_{oc}(T_o, C_o)}{\beta(C)} \quad (4)$$

where T_o is the environment temperature, $V_{oc}(T_c, C)$ is the open circuit voltage function of the cell temperature and concentration factor, $V_{oc}(T_o, C_o)$ is the open circuit voltage function of the environment temperature and concentration factor equal to 1, $\beta(C)$ is the voltage thermal coefficient. This expression is not usable as it requires the knowledge of parameters that can be only empirically obtained. It is possible, therefore, to consider some experimental diagrams of the variables examined (Steiner et al., 2011). The open circuit voltages depend on the cell temperature that represents the unknown. This can be overcome considering a relation deduced graphically (Cotal et al., 2009) where V_{oc} depends only on the concentration factor:

$$V_{oc}(C) = 2.5847 + 0.085283 \cdot \ln(C) \quad (5)$$

The voltage thermal coefficient depends also on C and is calculated as (Steiner et al., 2011):

$$\beta(C) = -0.006424 + 0.00036233 \cdot \ln(C) \quad (6)$$

As a consequence of these assumptions, the cell temperature is equal to:

$$T_c = T_o + \frac{V_{oc}(C) - V_{oc}(C_o)}{|\beta(C)|} \quad (7)$$

Once known the cell temperature, the cell efficiency can be determined. Also in this case it is not possible to define a theoretical equation between the quantities examined, but it is possible to use some experimental diagrams (Steiner et al., 2011) which show the efficiency decrease when the concentration factor increases at the same cell temperature. Hence, the cell efficiency is calculated as:

$$\eta_c - \eta_r = \frac{d\eta}{dT} \cdot (T_c - T_r) \quad (8)$$

where the reference temperature T_r is equal to 25°C and η_r is the reference efficiency corresponding to the concentration factor chosen. The factor $\frac{d\eta}{dT}$, for C factors greater than 30 and according to the curves analyzed, is equal to:

$$\frac{d\eta}{dT} = -0.09167 + 0.005787 \cdot \ln(C) \quad (9)$$

2.4 Electric and Thermal Energy

The electrical energy theoretically produced by a single cell, using a concentration system with biaxial motion, is equal to (Kribus et al., 2006; Mittelman et al., 2007):

$$P_c = \eta_c \cdot \eta_{opt} \cdot A_c \cdot C \cdot (G_{dir,r} \cdot f) \quad (10)$$

where $G_{dir,r}$ represents the direct irradiance previously calculated and, considering a non ideal tracking system, a factor f equal to 0.9 is considered. The system optical efficiency with parabolic concentrator mirrors is equal to (Brogen, 2004):

$$\eta_{opt} = \tau \cdot \left[p + \frac{1}{c} \cdot \left(1 - \frac{p}{0.98} \right) \right] \quad (11)$$

where τ and ρ represent the transmission and reflectivity coefficients of the mirrors; the value 0.98 is the ratio between the areas of the photovoltaic cell and the concentrator. In order to determine the electric energy actually delivered by the cell, the power thermal coefficient (k_t), which indicates the percentage decrease of the electricity supplied by the system at a given operating temperature, has to be defined $k_t = 1 + \sigma_t \cdot (T_c - 25)$ where σ_t is the temperature coefficient dependent on cell type and manufacturer; analyzing many data sheets a σ_t value equal to -0.16% has been chosen. Hence, the electrical energy actually delivered by the cell is equal to $P_{c,r} = k_t \cdot P_c$.

To calculate the module electric energy, it is necessary to consider the cells number that constitute it and its efficiency (η_{mod}) fixed equal to 0.9 (Kribus et al., 2006). This value takes into account the coupling in series of the cells along a line, considering the possibility that a cell can operate at a efficiency lower than the nominal one. Hence, the electric energy delivered by the module is equal to:

$$P_{mod} = P_{c,r} \cdot n_c \cdot \eta_{mod} \quad (12)$$

The value obtained has to be reduced taking into account the parasitic current losses generated in the module, defined as (Kribus et al., 2006):

$$P_{par} = P_{par} \cdot G_{dir,r} \cdot A_c \cdot C \cdot n_c \quad (13)$$

where p_{par} is a loss factor depending on the radiation and equal to 0.023 (Kribus et al., 2006). So, considering the inverter efficiency (η_{inv}) fixed equal to 0.9 (Mittelman et al., 2007) and cells linked in series, the actual electric energy provided by module is equal to:

$$P_{mod,r} = (P_{mod} - P_{par}) \cdot \eta_{mv} \quad (14)$$

The thermal energy ideally delivered by the module is equal to (Mittelman et al., 2007):

$$Q_{th,ideal} = (1 - \eta_{pv}) \cdot \eta_{opt} \cdot C \cdot (G_{dir,r} \cdot f) \cdot A_c \cdot n_c \quad (15)$$

where the concentrating photovoltaic module overall efficiency (η_{pv}) considers all the system losses and is equal to (Kribus et al., 2006):

$$\eta_{pv} = \eta_c \cdot \eta_{mod} \cdot k_t \quad (16)$$

Moreover, the solar rays which act on the triple-junction cell determine its heating and thermal energy dispersion because of radiative and convective phenomena (Mittelman et al., 2007):

$$Q_{th,t} = [\bar{h}_c \cdot (T_c - T_0) + \varepsilon_c \cdot \sigma \cdot (T_c^4 - T_0^4)] A_c \cdot n_c \quad (17)$$

where ε_c is the cell emissivity equal to 0.85. The actual thermal energy is equal to the difference between the theoretical total thermal energy and the radiative and

convective losses generally included in the range 1÷ 3% (Kribus et al., 2006).

2.5 Fluid Outlet Temperature

The CPV/T system model allows also the calculation of the fluid outlet temperature ($T_{f,out}$), usually water and glycol, used to cool the cells and to provide thermal energy to a domestic application. In particular, the sun rays focused on the triple-junction cell allow the heating of the absorber plate, placed immediately below the cells (Figure 1). The polymeric insulating material is used in order to avoid heat loss. The equation that regulates the exchange between the cell and plate is (Kribus et al., 2006):

$$\dot{Q}_{th,r} = K \cdot (T_c - T_p) \quad (18)$$

from which the plate temperature can be obtained once calculated the real thermal power. Once considered the system CPV/T dimensions and the conductivities values of the substrate between the cell and cooling plate and assuming a homogeneous and isotropic model, a K value has been determined. In order to satisfy the sanitary hot water, heating and cooling demands related to a domestic application, it is necessary to determine $T_{f,out}$. This temperature has been calculated assuming that the absorber plate temperature (T_p) is uniform (Kribus et al., 2006). Considering the first law and the design equation of a heat exchanger, the following equation is obtained:

$$\begin{aligned} \dot{Q}_{h,e} &= \dot{m} \cdot c \cdot (T_{out} - T_{in}) = \\ &= \bar{h}_c \cdot A_{cool} \cdot \Delta T_{ml} \cdot (T_{out}, T_{in}) = \bar{h}_c \cdot A_{cool} \cdot \frac{T_{out} - T_{in}}{\ln\left(\frac{T_p - T_{in}}{T_p - T_{out}}\right)} \end{aligned} \quad (19)$$

where T_{out} and T_{in} are the outlet and inlet fluid temperatures and UA is the global conductance. Hence, the outlet fluid temperature is equal to:

$$T_{out} = T_p - \frac{T_p - T_{in}}{e^{\frac{\bar{h}_c \cdot A_{h,e}}{m \cdot c}}} \quad (20)$$

3. ENERGY ANALYSIS RESULTS

The model has allowed a daily, monthly and annual results evaluation in order to identify the main technical characteristics necessary for the realization of the most efficient CPV/T system. The main input variables of the simulation process are: installation site, optics type, cells size, cells number of the module and concentration factor. In particular, in the CPV/T system simulation two types of optics have been considered: Fresnel lenses and parabolic mirror concentrators of point-focus type. In the simulation the cells size has been varied between 1 cm² and 1.5 cm² in the system with lenses, and between 8 mm² and 9 mm² with mirrors; the concentration factor has been varied in the range 600x and 900x and the cells

number per module between 60 and 120. The model has allowed to realize simulations in all Italy and to define the optimal concentration system, especially in southern Italy where the CPV/T system is resulted more convenient. The energy demands of a house are determined related to the site considered. 80 and 200 m² houses inhabited by 2 to 6 people have been considered. The average annual electric demand varies between 19 and 30 kWh/m². For example, an electric consumption of about 2820 kWh/year has been estimated for a house of 100 m² inhabited by 4 people in Rome. The calculation related to the sanitary hot water is based on the f-chart method (Klein and Beckman, 1993); considering an average index of 75 liters/day per person, 300 kWh of thermal energy per month are on average required. Energy consumption for heating and cooling depends on the site considered and their evaluation has been carried out monthly. For example, the energy required for heating during the winter months is on average equal to about 1800 kWh per month in Palermo; as for the cooling the AHP cooling peak power is 7 kW, with monthly average requirements of cooling energy of about 1100 kWh per month. The model presented allows varying both the input conditions and the load for different time intervals (yearly, monthly, daily, hourly) and to size, then, the CPV/T system according to the site and energy demands. The annual simulation has allowed evaluating both the most suitable optical device and optimal cells number able to satisfy the electric and thermal energy demands and to obtain low module size and high fluid outlet temperature necessary for the AHP working. The yearly simulation results represent the input of the monthly simulation that has allowed evaluating the high potential of the CPV/T system in southern Italy and not in northern Italy, and the concentration factor able to satisfy the electric energy demand with a low modules number. In particular, from northern to southern Italy, the modules number required decreases from three to two in order to satisfy the electric load. Related to the optics used, the concentrator mirrors allow obtaining electric energy about 10% higher than the refractive optics because of the Fresnel lens chromatic aberration for high concentration factor values. Moreover, the electric and thermal monthly efficiencies obtained from the model have been compared with small differences with those reported in (Kribus et al., 2006) in the same working conditions considering a fluid outlet temperature of about 90°C; the module electric efficiency decreases with the concentration factor differently from the thermal efficiency (Figure 4). The CPV/T system structure with two modules of 90 cells is the best solution to satisfy on average the energy demands (electricity, heating and cooling) in southern Italy. In particular, the Figures 5 and 6 show the electric and thermal energy produced in Milan and Palermo by a single module when the cells number and the concentration factor vary. The electric and thermal energy production increases when the concentration factor and

number of cells increase, with absolute values higher in Palermo. The CPV/T systems satisfy the cooling demands adopting an absorption heat pump (AHP); the fluid outlet temperature increases with the concentration factor. The choice of the cells number that constitute the module has to be a good compromise between the electric and thermal energy demands and the fluid temperature values of about 90°C to make possible the AHP use. Coupling CPV/T and AHP, the cooling capacity is equal to $\dot{Q}_r = \dot{Q}_{th,in} \cdot COP$. The COP of a single-stage AHP has been considered, while the input thermal power can be calculated in terms of the fluid mass flow rate and difference between the fluid and mains water temperatures. The AHP cooling power obtained and the fluid outlet temperature depend on the concentration factor (Figure 7). Varying the concentration factor, the fluid temperatures allow to obtain defined cooling powers. For example, related to the peak power of 7 kW the temperatures necessary to operate are obtainable only with a high concentration factor; it can be observed that the AHP use is possible for concentration factor values above 200x. The CPV/T system model presented in this paper allows evaluating its convenience in energy terms respect to a traditional solution. In order to satisfy the energy demands of a 120 m² house inhabited by 4 people in Palermo, the CPV/T system, dimensioned on the electricity demand, uses two modules that occupy 28.9 m² with 90 cells per module of area equal to 81 mm²; the CPV/T system has a reflective optics and a high concentration factor. The energy analysis (Figure 8) compares the thermal energy flows provided by the CPV/T system, including the thermal energy for heating, sanitary water hot and AHP working, and those required by a house. In Figure 8a a good performance of the CPV/T system can be noted in Palermo, differently from Milan (Figure 8b) where the energy saving in terms of heating and cooling is high. Once verified the advantages of a CPV/T system in terms of energy, an economic analysis has been realized comparing the CPV/T system with a traditional system operating in the same conditions. The maintenance and working costs are related to the modules cleaning, the imperfect components replacement, the control system and the insurance in case of malfunctions due to weather conditions or human error. These costs depend on the system size and together with the plant cost (CPV/T system and AHP cost) constitute the CPV/T system total cost (Mastrullo and Renno, 2010). The AHP cost, with a cooling capacity of 7 kW_f, is about 350 €/kW_f (Gebreslassie et al., 2009). The cost of the modules takes into account the different devices necessary; the cells number and a cost per cell of 7 €/m² are considered, while the optics cost is estimated in 140 €/m² of the concentrator area (Kribus et al., 2006; Mittelman et al., 2007). Referring to Palermo and considering a useful life of the CPV/T system of 20 years, a discount pay back of about 8 years, a net present value of about 10 k€ and an internal rate of return equal to 13%, compared to a discount rate of 3%, have been obtained.

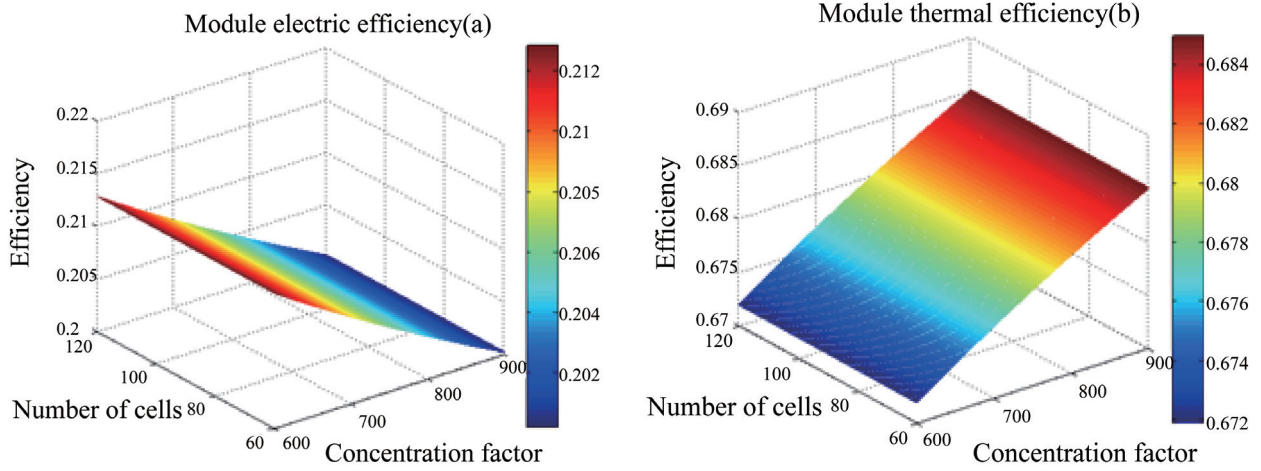

Figure 4
Electric Efficiency (a) and Thermal Efficiency (b) as Function of C and Cells Number

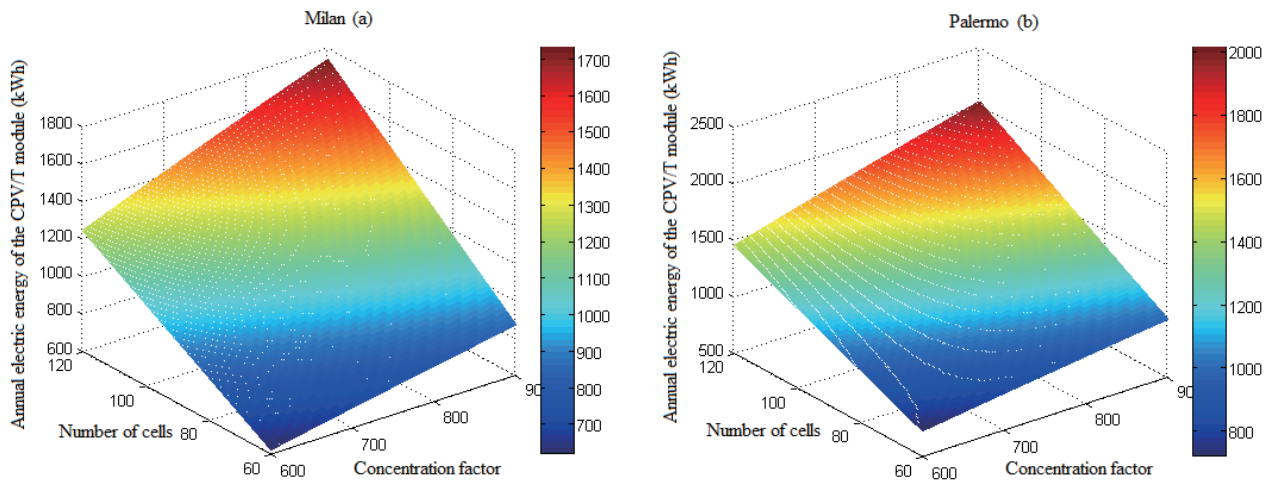

Figure 5
Annual Electric Energy of the CPV/T Module: Milan (a) and Palermo (b)

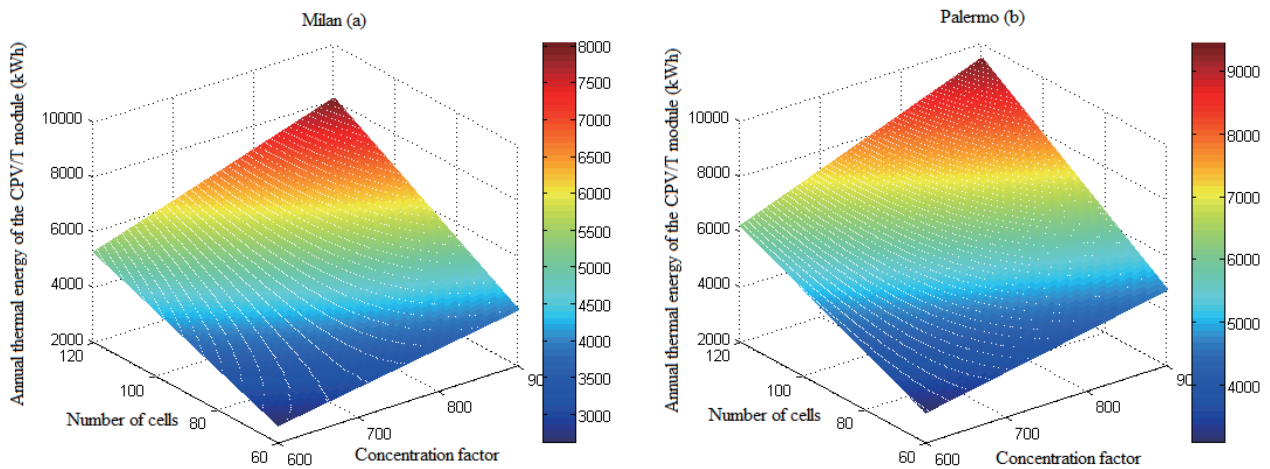

Figure 6
Annual Thermal Energy of the CPV/T Module: Milan (a) and Palermo (b)

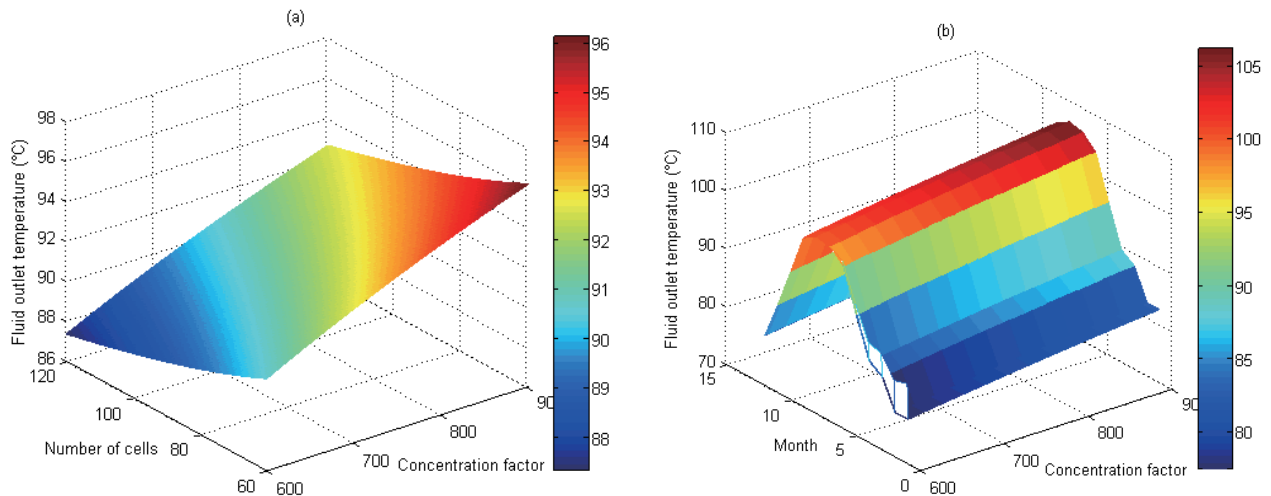

Figure 7
Fluid Outlet Temperature in Terms of C, Cells Number (a) and Month (b)

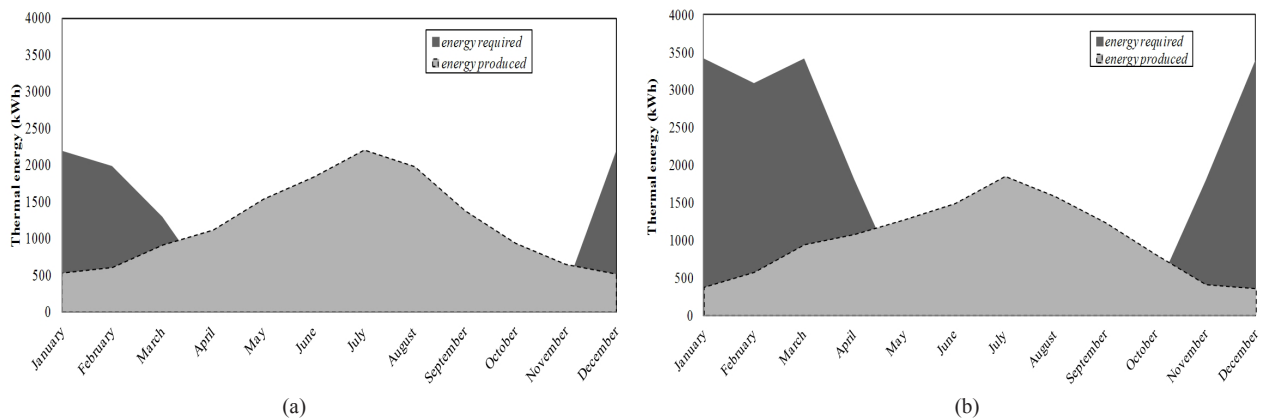

Figure 8
Thermal Energy Required in Palermo (a) and in Milan (b)

CONCLUSION

In this paper the potential of the concentrating photovoltaic technology has been evaluated from the thermal point of view. The main aims have been the size and the simulation in Matlab of a concentrating photovoltaic thermal (CPV/T) system under different operating conditions, referring to a domestic application in order to evaluate its convenience from the energy and economic point of view. The components of the CPV/T system have been defined. Referring to systems with high levels of concentration ($600x < C < 900x$), two different types of optical devices have been considered: refraction (Fresnel lenses) and reflective (concentrators with parabolic mirrors). Referring to the multi-junction cells, ideal in high concentration, InGaP/InGaAs/Ge triple-junction cells have been chosen. The system is completed with a dual axis tracking system and an active cooling system of the solar cells. The model allows analyzing the CPV/T system working at different time levels (yearly, monthly, daily, and hourly) in terms of: cell efficiency,

electrical and thermal module efficiency, cell and fluid temperatures, thermal and electrical energy provided either by the single cells or module. The simulation process has allowed defining the best configuration of the CPV/T system under different operating conditions. With reference to southern Italy the CPV/T system is constituted by: a reflective optics with concentrating mirrors, high concentration factor, cells with area equal to 81mm^2 and two modules with 90 cells. This configuration allows obtaining energy that makes the house independent from the electric and cooling demands, while thermal energy integration is necessary for few months of the year. The fluid outlet temperature obtained allows using an AHP with a CPV/T system. An economic analysis that compares the CPV/T system with a traditional system operating in the same conditions has been also conducted. The model presented is a good tool to evaluate the CPV/T system performance applied to a domestic application, but its installation has to take into account the site conditions specifications.

NOMENCLATURE

A	area (m ²)
a	constant
SHW	sanitary hot water
AM	air mass
C	concentration ratio
c	specific heat (kJ/kgK)
c _n	cloud cover factor
CPV	concentrating photovoltaic system
CPV/T system	concentrating photovoltaic thermal system
DNI	direct normal irradiance (kWh/m ²)
EoT	equation of time (min)
f	safety factor
G ₀	solar constant (W/m ²)
G _{dir}	direct solar irradiance (kWh/m ²)
G _{dir,r}	real direct solar irradiance (kWh/m ²)
h	altitude (km)
HRA	hourly angle (°)
K	conductive conductance (W/K)
k _t	thermal coefficient
LST	local solar time (hours)
LSTM	local standard time meridian (°)
LT	local time (hours)
n	days number
n _c	cells number
P	electric energy (kWh); loss factor
Q	thermal energy (kWh)
T	temperature (°C)
TC	correction factor (min)
U	unitary global conductance (W/m ² K)
V _{oc}	open circuit voltage (V)
ΔT _{gmt}	difference between meridians
ΔT _{ml}	logarithmic mean difference (°C)
ṁ	mass flow rate (kg/s)
Q̇	thermal power (kW)

GREEK SYMBOLS

α	solar elevation (°)
δ	solar declination (°)
ε	emissivity coefficient
η	efficiency
θ _z	zenith angle (°)
ρ	reflectivity coefficient
σ	Stefan-Boltzmann constant ($\frac{W}{m^2 \times K^4}$)
σ _t	temperature coefficient (% / °C)
τ	transmittance coefficient
φ	latitude (°)
ω _s	hour angle of astronomical sunset (°)

SUBSCRIPTS

c	cell
f	fluid
h,e	heat exchanger
id	ideal
in	inlet
inv	inverter
l	loss
m,w	mains water
mod	module
o	environment
opt	optic
out	outlet
p	plate
par	parasitic losses
pv	photovoltaic
r	real, refrigeration
th	thermal
w	water

REFERENCES

- Brogen, M. (2004). *Optical efficiency of low-concentrating solar energy systems with parabolic reflectors* (Doctoral dissertation). Acta Universitatis Upsaliensis, Uppsala, Sweden.
- Cotal, H., Fetzer, C., Boisvert, J., Kinsey, G., King, R., Hebert, P., ..., Karam, N. (2009). III–V multijunction solar cells for concentrating photovoltaics. *Energy & Environmental Science*, 2, 174-192.
- Desiato, F., Lena, F., Baffo, F., Suatoni, B., & Toreti, A. (2006). *Indicators of climate in Italy processed through the system SCIA* (in Italian). Italy: APAT.
- Gebreslassie, B. H., Guillén-Gosálbez, G., Jiménez, L., & Boer, D. (2009). Economic performance optimization of an absorption cooling system under uncertainty. *Applied Thermal Eng.*, 29, 3491-3500.
- Kasten, F., & Young, A. T. (1989). Revised optical air mass tables and approximation formula. *Applied Optics*, 28, 4735-4738.
- Klein, S. A., & Beckman, W. A. (1993). F-chart solar energy system analysis: Version 6.17W. F-Chart Software, 4406 Fox Bluff Road, Middleton, Wisc. 53562, USA.
- Kribus, A., Kaftori, D., Mittelman, G., Hirshfeld, A., Flitsanov, Y., & Dayan, A. (2006). A miniature concentrating photovoltaic and thermal system. *Energy Conversion and Management*, 47, 3582-3590.
- Kurtz, S. (2009). *Opportunities and challenges for development of a mature concentrating photovoltaic power industry* (Technical report NREL/TP-520-43208). U.S. Department of Energy.
- Laue, E. G. (1970). The measurement of solar spectral irradiance at different terrestrial elevations. *Solar Energy*, 13, 43-50, IN1-IN4, 51-57.

- Li, M., Li, G. L., Ji, X., Yin, F., & Xua, L. (2011). The performance analysis of the Trough Concentrating Solar Photovoltaic/Thermal system. *Energy Conversion and Management*, 52, 2378-2383.
- Luque, A., Sala, G., & Arboiro, J. C. (1998). Electric and thermal model for non-uniformly illuminated concentration cells. *Solar Energy Materials and Solar Cells*, 51, 269-290.
- Mastrullo, R., & Renno, C. (2010). A thermoeconomic model of a photovoltaic heat pump. *Applied Thermal Engineering*, 30, 1959-1966.
- Matlab R2007b. The MathWorks. Natick, Massachusetts (USA).
- Mittelman G., Kribus A., & Dayan A. (2007). Solar cooling with concentrating photovoltaic/thermal (CPVT) systems. *Energy Conversion and Management*, 48, 2481-2490.
- Mokri, A., & Emziane, M. (2011). Concentrator photovoltaic technologies and market: A critical review, *World Renewable Energy Congress*, Sweden.
- Mousazadeh, H., Keyhani, A., Javadi, A., Mobli, H., Abrinia, K., & Sharifi, A. (2009). A review of principle and sun-tracking methods for maximizing solar systems output. *Renewable and Sustainable Energy Reviews*, 13, 1800-1818.
- Steiner, M. A., Geisz, J. F., Friedman, D. J., Olavarria, W. J., Duda, A., & Moriarty, T. E. (2011, June). Temperature-dependent measurements of an inverted metamorphic multijunction (IMM) solar cell. Paper presented at the 37th IEEE Photovoltaic Specialists Conference, Seattle, Washington.
- Technical standard UNI 8477-1. (1983). Italy.
- Vossier, A., Chemisana, D., Flamant, G., & Dollet, A. (2012). Very high fluxes for concentrating photovoltaic: Considerations from simple experiments and modeling. *Renewable Energy*, 38, 31-39.
- Zahedi, A. (2011). Review of modeling details in relation to low-concentration solar concentrating photovoltaic. *Renewable and Sustainable Energy Reviews*, 15, 1609-1614.
- Zhai, H., Dai, Y. J., Wu, J. Y., Wang, R. Z., & Zhang L. Y. (2010). Experimental investigation and analysis on a concentrating solar collector using linear Fresnel lens. *Energy Conversion and Management*, 51, 48-55.